

Ergebnis: **184.5** (176)
 Serien: 94.4 90.1
 Zähler: 3 12 4 0 1 0 0 0 0 0 0
 Innenzehner: 1
 Weitester: 1092 (17.), 738 (16.), 688 (2.)
 beste Teiler: 183.0 (1.), 210.0 (6.), 234.0 (4.)
 Trefferlage: 1.59 mm links, 0.35 mm tief
 Streuwert: 3.31, horizontal: 4.23, vertikal: 2.02

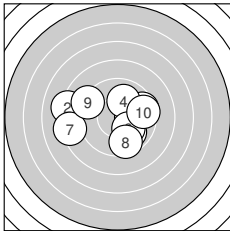
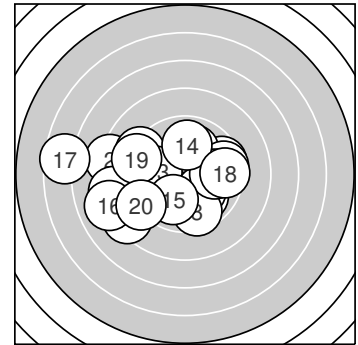

Serie 1: 94.4 (91)

10.2* →	8.2 ←	9.5 →	10.0 ↑	9.9 ↘
10.1 ↘	8.3 ←	9.6 ↓	9.1 ←	9.5 →

beste Teiler: 183.0 (1.), 210.0 (6.), 234.0 (4.)
 Trefferlage: 0.36 mm links, 0.09 mm tief
 Streuwert: 3.05, horizontal: 3.88, vertikal: 1.89

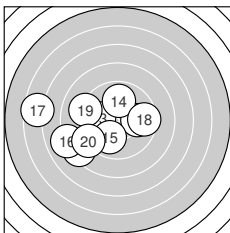

Serie 2: 90.1 (85)

8.3 ↙	9.9 →	9.9 ←	9.9 ↑	9.9 ↓
8.0 ←	6.6 ←	9.5 →	9.1 ←	9.0 ↙

beste Teiler: 252.2 (13.), 253.2 (15.), 262.6 (14.)
 Trefferlage: 2.83 mm links, 0.61 mm tief
 Streuwert: 3.48, horizontal: 4.39, vertikal: 2.22



Ergebnis: **203.7** (196)
 Serien: 101.1 102.6
 Zähler: 16 4 0 0 0 0 0 0 0 0 0
 Innenzehner: 11
 Weitesten: 489 (15.), 401 (3.), 306 (2.)
 beste Teiler: 20.0 (4.), 32.9 (16.), 36.1 (5.)
 Trefferlage: 0.18 mm rechts, 0.60 mm hoch
 Streuwert: 1.56, horizontal: 1.80, vertikal: 1.28

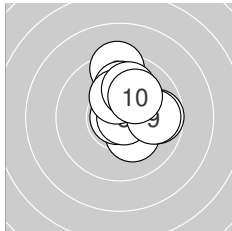
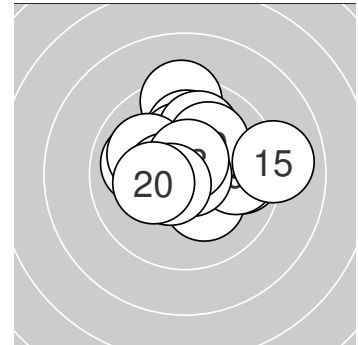

Serie 1: 101.1 (97)

10.2* ↘	9.7 →	9.3 ↑	10.9* ←	10.8* →
10.0 ↑	10.3* ↑	10.0 ↑	9.8 →	10.1 ↗

beste Teiler: 20.0 (4.), 36.1 (5.), 170.9 (7.)
 Trefferlage: 0.87 mm rechts, 1.07 mm hoch
 Streuwert: 1.43, horizontal: 1.21, vertikal: 1.61

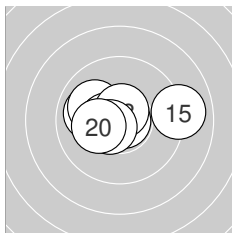

Serie 2: 102.6 (99)

10.0 ←	10.0 ↘	10.4* ←	10.5* ←	9.0 →
10.8* →	10.5* ←	10.6* ↑	10.6* ↙	10.2* ←

beste Teiler: 32.9 (16.), 77.6 (18.), 98.4 (19.)
 Trefferlage: 0.50 mm links, 0.13 mm hoch
 Streuwert: 1.52, horizontal: 2.07, vertikal: 0.59



Ergebnis: **184.0** (176)
 Serien: 92.9 91.1
 Zähler: 5 8 5 2 0 0 0 0 0 0
 Innenzehner: 4
 Weitestе: 931 (2.), 847 (15.), 621 (19.)
 beste Teiler: 49.2 (12.), 51.0 (10.), 147.9 (1.)
 Trefferlage: 2.71 mm links, 2.12 mm tief
 Streuwert: 2.58, horizontal: 3.15, vertikal: 1.85

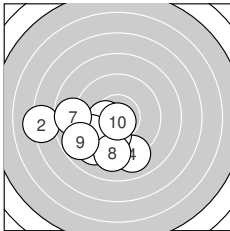
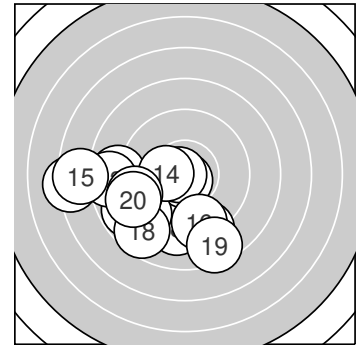

Serie 1: 92.9 (89)

10.4* ←	7.2 ←	9.2 ↘	9.0 ↓	10.1 ↓
9.5 ↘	8.8 ←	9.2 ↓	8.8 ↘	10.7* ↓

beste Teiler: 51.0 (10.), 147.9 (1.), 224.3 (5.)
 Trefferlage: 2.61 mm links, 2.07 mm tief
 Streuwert: 2.55, horizontal: 3.19, vertikal: 1.68

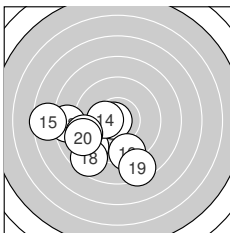

Serie 2: 91.1 (87)

9.1 ↘	10.8* ←	8.5 ←	10.3* ←	7.6 ←
9.3 ↓	9.2 ↘	8.7 ↘	8.5 ↓	9.1 ↘

beste Teiler: 49.2 (12.), 153.1 (14.), 405.9 (16.)
 Trefferlage: 2.81 mm links, 2.16 mm tief
 Streuwert: 2.75, horizontal: 3.28, vertikal: 2.09



Ergebnis: **206.4** (195)
 Serien: 102.1 104.3
 Zähler: 15 5 0 0 0 0 0 0 0 0 0
 Innenzehner: 15
 Weitestе: 406 (8.), 323 (18.), 306 (4.)
 beste Teiler: 47.1 (19.), 54.4 (9.), 65.0 (13.)
 Trefferlage: 0.41 mm links, 0.43 mm hoch
 Streuwert: 1.29, horizontal: 1.56, vertikal: 0.92

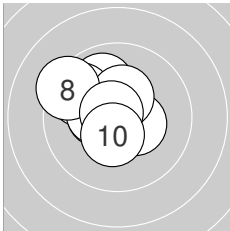
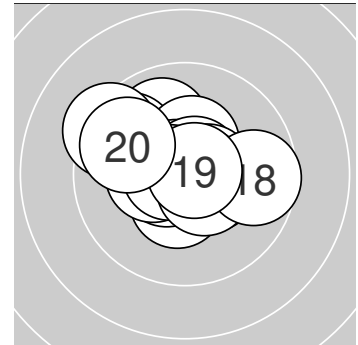

Serie 1: 102.1 (97)

10.5* ↑	9.9 ↖	10.4* ←	9.7 ↖	10.4* →
10.4* ←	10.4* ↑	9.3 ↖	10.7* ↖	10.4* ↓

beste Teiler: 54.4 (9.), 117.6 (1.), 129.1 (10.)
 Trefferlage: 0.93 mm links, 0.75 mm hoch
 Streuwert: 1.27, horizontal: 1.39, vertikal: 1.14

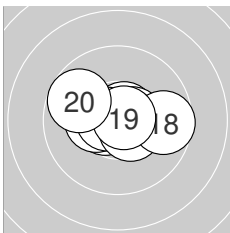

Serie 2: 104.3 (98)

10.6* ←	10.4* ←	10.7* ↗	10.5* →	10.7* ←
10.7* →	10.5* ↘	9.7 →	10.8* →	9.7 ↖

beste Teiler: 47.1 (19.), 65.0 (13.), 68.0 (16.)
 Trefferlage: 0.09 mm rechts, 0.11 mm hoch
 Streuwert: 1.21, horizontal: 1.63, vertikal: 0.53



Ergebnis: **191.0** (180)
 Serien: 95.5 95.5
 Zähler: 6 9 4 1 0 0 0 0 0 0 0
 Innenzehner: 5
 Weitester: 768 (16.), 672 (5.), 635 (3.)
 beste Teiler: 37.0 (10.), 112.4 (11.), 121.1 (4.)
 Trefferlage: 0.13 mm links, 0.19 mm tief
 Streuwert: 2.91, horizontal: 3.84, vertikal: 1.49

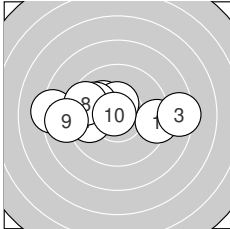
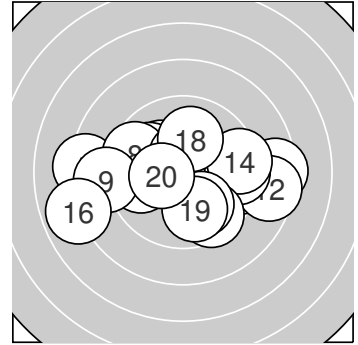

Serie 1: 95.5 (90)

9.3 → 10.2* ↘ 8.4 →
 9.9 ↖ 9.8 ← 9.5 ↖
 beste Teiler: 37.0 (10.), 121.1 (4.), 200.5 (2.)
 Trefferlage: 1.20 mm links, 0.37 mm hoch
 Streuwert: 2.87, horizontal: 3.98, vertikal: 0.80

10.5* ↑ 8.3 ←
 8.8 ← 10.8* ↖

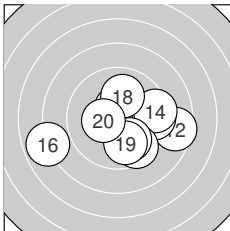

Serie 2: 95.5 (90)

10.5* ↑ 8.5 → 9.5 →
 7.9 ← 9.9 ↘ 10.0 ↑
 beste Teiler: 112.4 (11.), 149.1 (20.), 232.6 (18.)
 Trefferlage: 0.93 mm rechts, 0.75 mm tief
 Streuwert: 2.84, horizontal: 3.59, vertikal: 1.81

9.4 → 9.5 ↘
 9.9 ↘ 10.4* ←



Ergebnis: **182.8** (173)
 Serien: 89.8 93.0
 Zähler: 3 10 4 3 0 0 0 0 0 0
 Innenzehner: 2
 Weitestе: 949 (15.), 830 (6.), 765 (8.)
 beste Teiler: 87.9 (11.), 187.6 (1.), 223.4 (18.)
 Trefferlage: 1.13 mm links, 1.39 mm hoch
 Streuwert: 3.42, horizontal: 4.42, vertikal: 1.95

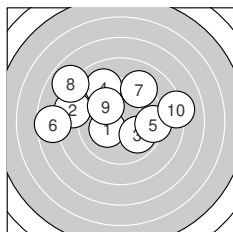
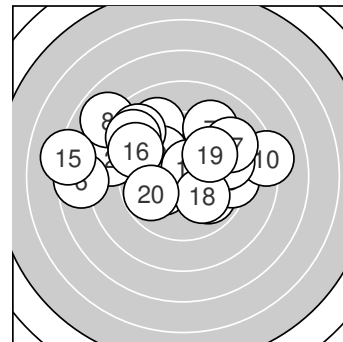

Serie 1: 89.8 (85)

10.2* ↙	8.5 ←	9.9 ↘	9.1 ↖	9.4 →
7.6 ←	9.1 ↗	7.9 ↘	9.9 ↘	8.2 →

beste Teiler: 187.6 (1.), 259.5 (9.), 262.6 (3.)
 Trefferlage: 1.07 mm links, 1.41 mm hoch
 Streuwert: 3.77, horizontal: 4.84, vertikal: 2.23

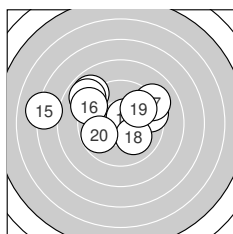

Serie 2: 93.0 (88)

10.6* ↗	9.4 →	8.9 ↘	8.9 ↘	7.2 ←
9.2 ↘	9.1 ↗	10.1 ↘	9.8 ↗	9.8 ↙

beste Teiler: 87.9 (11.), 223.4 (18.), 281.5 (19.)
 Trefferlage: 1.18 mm links, 1.37 mm hoch
 Streuwert: 3.23, horizontal: 4.23, vertikal: 1.74



Ergebnis: 182.3 (171)
Serien: 91.1 91.2
Zähler: 2 10 6 1 1 0 0 0 0 0 0
Innenzehner: 2
Weiteste: 1141 (16.), 885 (3.), 666 (7.)
beste Teiler: 187.7 (14.), 190.8 (9.), 271.0 (8.)
Trefferlage: 0.47 mm rechts, 2.23 mm tief
Streuwert: 3.35, horizontal: 4.12, vertikal: 2.32

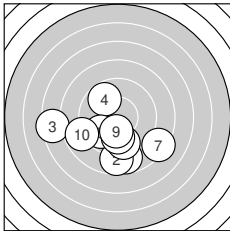
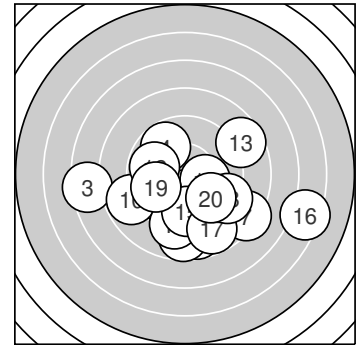

Serie 1: 91.1 (85)

8.7 ↓	8.7 ↓	7.4 ←	9.8 ↖	9.8 ↙
9.5 ↓	8.3 ↘	9.9 ↓	10.2* ↓	8.8 ↙

beste Teiler: 190.8 (9.), 271.0 (8.), 299.4 (4.)
Trefferlage: 1.05 mm links, 2.58 mm tief
Streuwert: 3.14, horizontal: 3.80, vertikal: 2.29

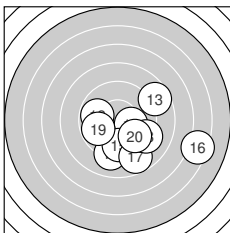

Serie 2: 91.2 (86)

9.1 ↓	9.8 ←	8.6 ↗	10.2* →	9.6 ↓
6.4 →	8.8 ↓	9.2 ↘	9.8 ↙	9.7 ↘

beste Teiler: 187.7 (14.), 281.3 (12.), 286.5 (19.)
Trefferlage: 2.00 mm rechts, 1.89 mm tief
Streuwert: 3.32, horizontal: 4.03, vertikal: 2.42



Ergebnis: 192.2 (184)
Serien: 97.9 94.3
Zähler: 11 7 1 0 0 0 0 1 0 0 0
Innenzehner: 7
Weiteste: 1841 (15.), 556 (3.), 480 (1.)
beste Teiler: 78.2 (17.), 80.8 (12.), 98.0 (9.)
Trefferlage: 2.16 mm links, 0.45 mm hoch
Streuwert: 3.23, horizontal: 4.03, vertikal: 2.17

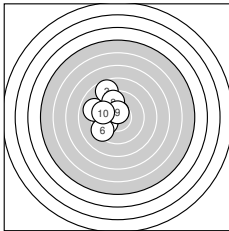
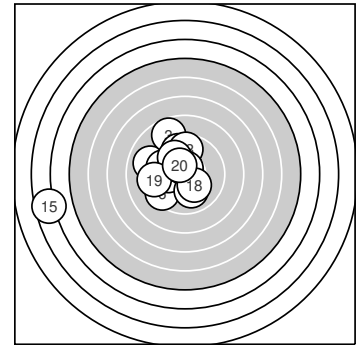

Serie 1: 97.9 (94)

9.0 ←	10.1 ←	8.7 ↗	10.0 ←	10.2* ↗
9.4 ↙	10.5* ↑	9.7 ↑	10.6* ↑	9.7 ←

beste Teiler: 98.0 (9.), 108.0 (7.), 196.8 (5.)
Trefferlage: 1.93 mm links, 0.97 mm hoch
Streuwert: 1.80, horizontal: 1.40, vertikal: 2.13

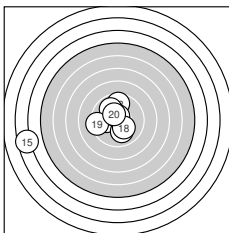

Serie 2: 94.3 (90)

10.1 ←	10.6* ↑	9.6 ↑	10.0 ↓	3.6 ←
9.9 ↘	10.6* ↑	10.2* ↘	9.3 ←	10.4* ↘

beste Teiler: 78.2 (17.), 80.8 (12.), 136.3 (20.)
Trefferlage: 2.40 mm links, 0.05 mm tief
Streuwert: 4.30, horizontal: 5.67, vertikal: 2.19



Ergebnis: **186.9** (179)
 Serien: 95.5 91.4
 Zähler: 7 7 4 2 0 0 0 0 0 0 0
 Innenzehner: 4
 Weitestе: 816 (19.), 764 (7.), 727 (14.)
 beste Teiler: 124.6 (6.), 125.6 (1.), 172.2 (13.)
 Trefferlage: 0.58 mm rechts, 0.88 mm tief
 Streuwert: 3.21, horizontal: 4.02, vertikal: 2.11

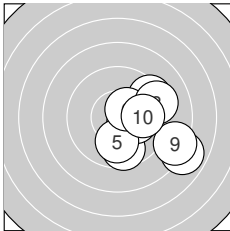
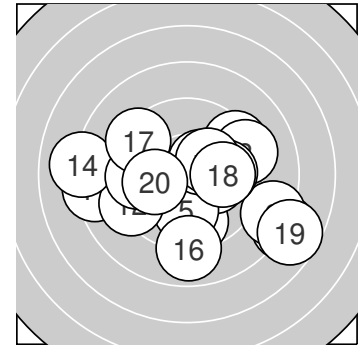

Serie 1: 95.5 (91)

10.5* ↘ 9.4 ↗ 9.6 ↓
 10.5* ↗ 7.9 ↘ 9.2 →
 beste Teiler: 124.6 (6.), 125.6 (1.), 191.3 (4.)
 Trefferlage: 2.70 mm rechts, 0.85 mm tief
 Streuwert: 2.18, horizontal: 2.29, vertikal: 2.07

10.2* → 10.0 ↓
 8.3 ↘ 9.9 →

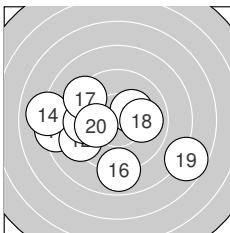

Serie 2: 91.4 (88)

8.4 ← 9.2 ← 10.3* ↗
 8.9 ↓ 9.3 ↘ 10.0 →
 beste Teiler: 172.2 (13.), 228.4 (20.), 247.0 (18.)
 Trefferlage: 1.52 mm links, 0.90 mm tief
 Streuwert: 3.47, horizontal: 4.36, vertikal: 2.27

8.0 ← 9.6 ←
 7.7 ↘ 10.0 ←



Ergebnis: **208.4** (198)
 Serien: 103.9 104.5
 Zähler: 18 2 0 0 0 0 0 0 0 0 0
 Innenzehner: 18
 Weitester: 338 (7.), 255 (3.), 190 (12.)
 beste Teiler: 20.6 (2.), 31.3 (20.), 40.8 (19.)
 Trefferlage: 0.07 mm links, 0.00 mm
 Streuwert: 1.11, horizontal: 1.28, vertikal: 0.90

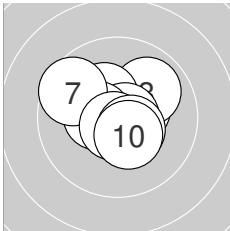
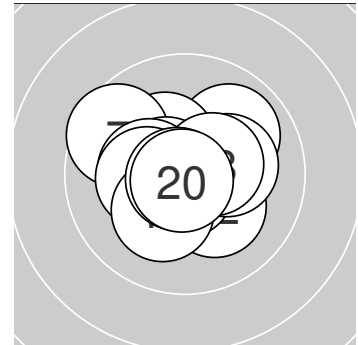

Serie 1: 103.9 (98)

10.4* ↗ 10.9* ↑ 9.9 ↗
 10.4* ← 9.6 ↖ 10.7* ↓
 beste Teiler: 20.6 (2.), 48.0 (5.), 62.6 (8.)
 Trefferlage: 0.01 mm links, 0.30 mm hoch
 Streuwert: 1.22, horizontal: 1.41, vertikal: 1.01

10.3* ↖ 10.8* →
 10.5* ↘ 10.4* ↘

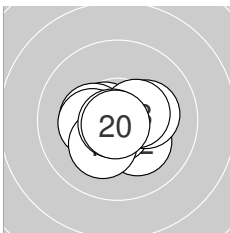

Serie 2: 104.5 (100)

10.6* ← 10.2* ↘ 10.7* ↓
 10.2* → 10.2* ↙ 10.4* →
 beste Teiler: 31.3 (20.), 40.8 (19.), 55.5 (13.)
 Trefferlage: 0.12 mm links, 0.29 mm tief
 Streuwert: 0.99, horizontal: 1.22, vertikal: 0.70

10.3* ← 10.3* ←
 10.8* ↖ 10.8* ↓



Ergebnis: **188.7** (178)
 Serien: 94.0 94.7
 Zähler: 5 10 3 2 0 0 0 0 0 0 0
 Innenzehner: 3
 Weitester: 765 (17.), 759 (10.), 555 (6.)
 beste Teiler: 93.4 (18.), 139.6 (19.), 166.1 (1.)
 Trefferlage: 1.33 mm links, 1.46 mm hoch
 Streuwert: 2.69, horizontal: 3.28, vertikal: 1.92

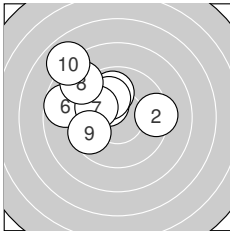
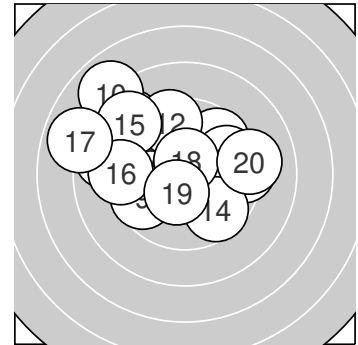

Serie 1: 94.0 (89)

10.3* ↘ 9.3 → 9.9 ↑
 8.7 ← 10.0 ↘ 8.9 ↘

beste Teiler: 166.1 (1.), 217.4 (5.), 243.7 (7.)
 Trefferlage: 2.13 mm links, 1.82 mm hoch
 Streuwert: 2.37, horizontal: 2.74, vertikal: 1.93

9.3 ↘ 10.1 ↗
 9.6 ↙ 7.9 ↘

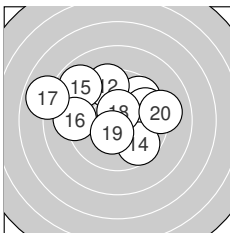

Serie 2: 94.7 (89)

9.7 ↗ 9.5 ↑ 9.7 →
 9.2 ← 7.9 ↙ 10.6* ↑

beste Teiler: 93.4 (18.), 139.6 (19.), 309.0 (13.)
 Trefferlage: 0.54 mm links, 1.11 mm hoch
 Streuwert: 2.97, horizontal: 3.72, vertikal: 1.95

9.7 ↘ 8.9 ↘
 10.4* ↘ 9.1 →



Ergebnis: **177.8** (168)
Serien: 90.3 87.5
Zähler: 5 3 8 3 1 0 0 0 0 0 0
Innenzehner: 5
Weiteste: 1142 (19.), 992 (3.), 882 (12.)
beste Teiler: 77.8 (18.), 94.2 (14.), 130.6 (1.)
Trefferlage: 2.31 mm links, 1.01 mm hoch
Streuwert: 3.96, horizontal: 5.24, vertikal: 1.99

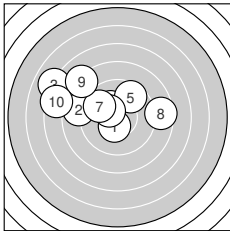
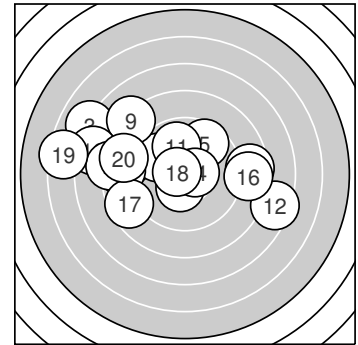

Serie 1: 90.3 (86)

10.4* ↙	8.8 ←	7.0 ↘	10.3* ↖	9.6 ↗
10.4* ↘	9.8 ↘	8.5 →	8.1 ↘	7.4 ←

beste Teiler: 130.6 (1.), 145.6 (6.), 175.8 (4.)
Trefferlage: 2.50 mm links, 1.88 mm hoch
Streuwert: 3.51, horizontal: 4.60, vertikal: 1.86

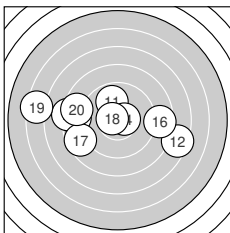

Serie 2: 87.5 (82)

9.9 ↑	7.4 →	8.6 ←	10.6* →	8.2 ←
8.6 →	8.6 ↙	10.6* ←	6.4 ←	8.6 ←

beste Teiler: 77.8 (18.), 94.2 (14.), 269.5 (11.)
Trefferlage: 2.13 mm links, 0.15 mm hoch
Streuwert: 4.46, horizontal: 6.06, vertikal: 1.79



Ergebnis: 188.4 (180)
Serien: 96.0 92.4
Zähler: 4 12 4 0 0 0 0 0 0 0
Innenzehner: 4
Weiteste: 665 (14.), 634 (19.), 621 (1.)
beste Teiler: 131.2 (2.), 140.7 (7.), 160.5 (8.)
Trefferlage: 0.42 mm rechts, 0.09 mm hoch
Streuwert: 3.01, horizontal: 3.70, vertikal: 2.10

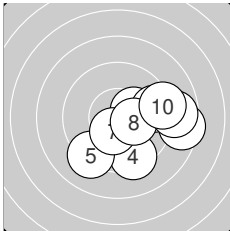
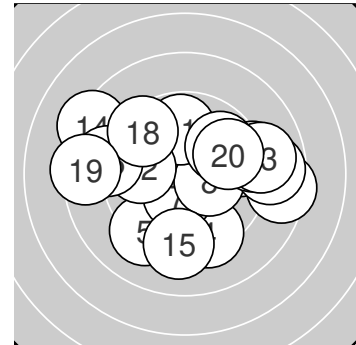

Serie 1: 96.0 (92)

8.5 →	10.4* ↘	10.3* →	9.4 ↓	9.2 ✓
9.5 →	10.4* ↓	10.3* →	8.8 →	9.2 →

beste Teiler: 131.2 (2.), 140.7 (7.), 160.5 (8.)
Trefferlage: 2.19 mm rechts, 0.78 mm tief
Streuwert: 2.25, horizontal: 2.68, vertikal: 1.71

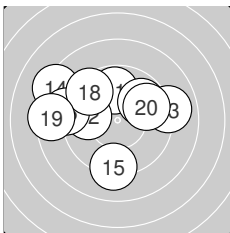

Serie 2: 92.4 (88)

9.8 ↑	9.8 ←	9.0 →	8.3 ↖	9.2 ↓
9.0 ←	9.8 ↗	9.4 ↘	8.4 ←	9.7 ↗

beste Teiler: 284.6 (12.), 285.0 (17.), 285.3 (11.)
Trefferlage: 1.35 mm links, 0.98 mm hoch
Streuwert: 3.11, horizontal: 3.84, vertikal: 2.16



Ergebnis: 197.0 (187)
Serien: 97.9 99.1
Zähler: 9 9 2 0 0 0 0 0 0 0 0
Innenzehner: 8
Weiteste: 624 (14.), 541 (2.), 476 (3.)
beste Teiler: 0.0 (20.), 8.0 (17.), 75.1 (9.)
Trefferlage: 0.53 mm rechts, 0.53 mm tief
Streuwert: 2.29, horizontal: 2.80, vertikal: 1.63

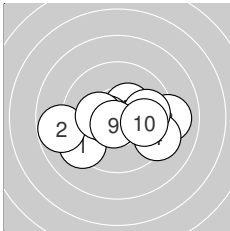
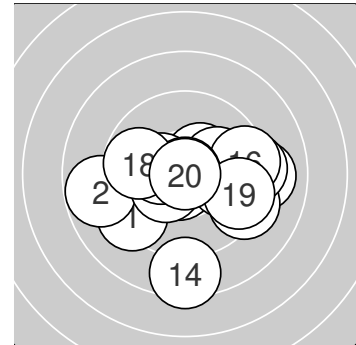

Serie 1: 97.9 (93)

9.3 ↙ 8.8 ← 9.0 →
 10.5* ← 9.8 → 10.2* ←
beste Teiler: 75.1 (9.), 101.7 (6.), 137.9 (5.)
Trefferlage: 0.29 mm rechts, 0.54 mm tief
Streuwert: 2.41, horizontal: 3.23, vertikal: 1.07

9.3 ↘ 10.4* ↗
 10.7* ↙ 9.9 →

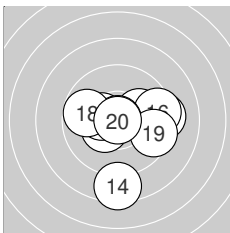

Serie 2: 99.1 (94)

9.3 → 10.4* ↙ 10.1 →
 9.4 → 10.9* ↑ 9.8 ←
beste Teiler: 0.0 (20.), 8.0 (17.), 145.0 (12.)
Trefferlage: 0.78 mm rechts, 0.52 mm tief
Streuwert: 2.28, horizontal: 2.44, vertikal: 2.11

8.5 ↓ 10.3* ←
 9.5 ↘ 10.9* →



Ergebnis: **126.6** (116)
 Serien: 63.7 62.9
 Zähler: 1 0 4 2 5 4 1 2 0 0 1
 Innenzehner: 1
 Weitester: 2799 (11.), 1996 (8.), 1863 (12.)
 beste Teiler: 70.6 (5.), 535.5 (18.), 543.5 (13.)
 Trefferlage: 6.13 mm links, 0.38 mm tief
 Streuwert: 8.33, horizontal: 8.27, vertikal: 8.39

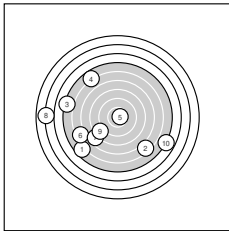
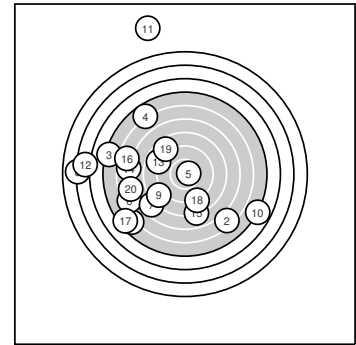

Serie 1: 63.7 (59)

5.6 ↙	6.3 ↘	5.1 ←	5.7 ↖	10.7* →
6.4 ↙	7.6 ↙	3.0 ←	8.5 ↙	4.8 ↘

beste Teiler: 70.6 (5.), 623.1 (9.), 842.3 (7.)
 Trefferlage: 5.07 mm links, 2.41 mm tief
 Streuwert: 8.34, horizontal: 10.03, vertikal: 6.21

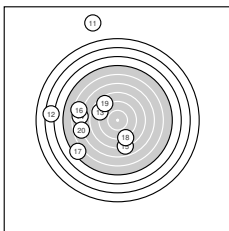

Serie 2: 62.9 (57)

0.0 ↑	3.5 ←	8.8 ↖	6.7 ←	7.9 ↓
6.5 ←	5.3 ↙	8.8 ↓	8.6 ↖	6.8 ←

beste Teiler: 535.5 (18.), 543.5 (13.), 586.8 (19.)
 Trefferlage: 7.20 mm links, 1.63 mm hoch
 Streuwert: 8.43, horizontal: 6.42, vertikal: 10.04



Ergebnis: **189.5** (180)
 Serien: 90.8 98.7
 Zähler: 9 3 7 1 0 0 0 0 0 0 0
 Innenzehner: 7
 Weitester: 833 (1.), 732 (5.), 694 (8.)
 beste Teiler: 41.8 (17.), 78.0 (10.), 83.5 (12.)
 Trefferlage: 0.22 mm links, 0.92 mm tief
 Streuwert: 3.13, horizontal: 3.37, vertikal: 2.88

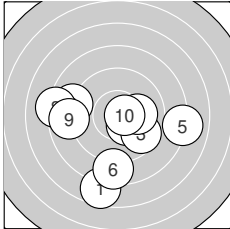
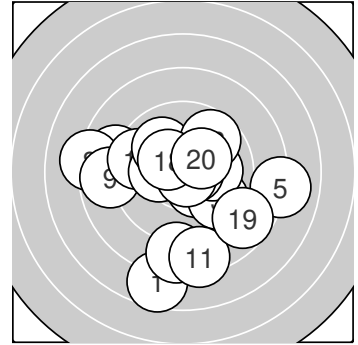

Serie 1: 90.8 (86)

7.6 ↓	10.4* ↘	9.6 ↘	8.9 ←	8.0 →
8.6 ↓	10.1 →	8.2 ←	8.8 ←	10.6* →

beste Teiler: 78.0 (10.), 148.7 (2.), 220.3 (7.)
 Trefferlage: 0.58 mm links, 1.64 mm tief
 Streuwert: 3.73, horizontal: 4.32, vertikal: 3.04

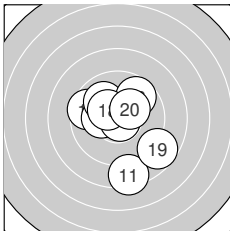

Serie 2: 98.7 (94)

8.4 ↓	10.6* ↑	9.6 ←	10.2* ←	10.0 ↘
9.7 ↗	10.8* ↘	10.4* ↘	8.7 ↘	10.3* ↗

beste Teiler: 41.8 (17.), 83.5 (12.), 144.1 (18.)
 Trefferlage: 0.13 mm rechts, 0.20 mm tief
 Streuwert: 2.45, horizontal: 2.24, vertikal: 2.65



Ergebnis: **199.2** (189)
 Serien: 101.1 98.1
 Zähler: 10 9 1 0 0 0 0 0 0 0 0
 Innenzehner: 8
 Weitestе: 521 (12.), 451 (19.), 442 (10.)
 beste Teiler: 71.8 (2.), 105.7 (1.), 113.2 (4.)
 Trefferlage: 1.15 mm links, 0.10 mm tief
 Streuwert: 1.85, horizontal: 2.13, vertikal: 1.52

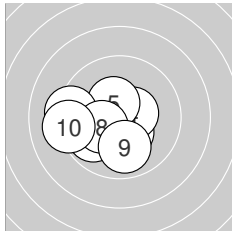
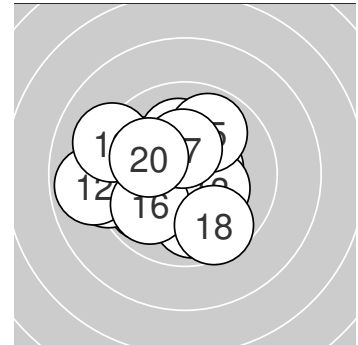

Serie 1: 101.1 (96)

10.5* ↓	10.7* ↖	10.4* ↓	10.5* →	10.4* ↗
9.9 ↙	9.3 ←	10.3* ↙	9.9 ↓	9.2 ←

beste Teiler: 71.8 (2.), 105.7 (1.), 113.2 (4.)
 Trefferlage: 1.08 mm links, 0.57 mm tief
 Streuwert: 1.59, horizontal: 1.96, vertikal: 1.12

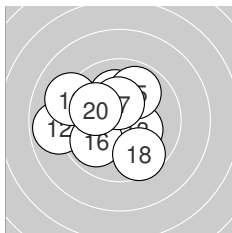

Serie 2: 98.1 (93)

9.8 ↖	8.9 ←	10.3* ↘	10.1 ↑	9.9 ↗
9.9 ↙	10.4* ↑	9.6 ↓	9.1 ↖	10.1 ↖

beste Teiler: 145.5 (17.), 166.0 (13.), 209.4 (14.)
 Trefferlage: 1.21 mm links, 0.35 mm hoch
 Streuwert: 2.10, horizontal: 2.39, vertikal: 1.77



Ergebnis: 182.9 (174)
Serien: 89.0 93.9
Zähler: 6 5 6 3 0 0 0 0 0 0 0
Innenzehner: 4
Weiteste: 943 (4.), 788 (3.), 780 (2.)
beste Teiler: 104.0 (10.), 115.2 (17.), 134.4 (13.)
Trefferlage: 0.27 mm links, 0.27 mm tief
Streuwert: 3.72, horizontal: 4.70, vertikal: 2.36

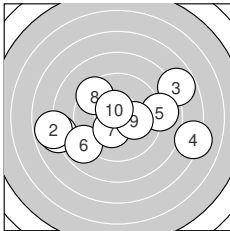
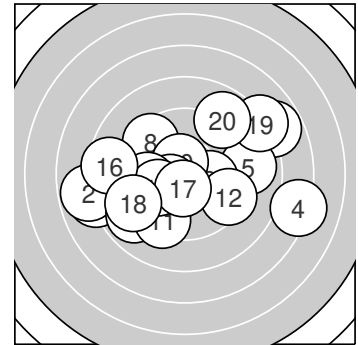

Serie 1: 89.0 (84)

8.0 ←	7.8 ←	7.8 →	7.2 →	8.9 →
8.9 ↙	10.3* ↓	9.5 ↘	10.1 →	10.5* ↗

beste Teiler: 104.0 (10.), 154.7 (7.), 202.5 (9.)
Trefferlage: 0.04 mm rechts, 0.34 mm tief
Streuwert: 4.34, horizontal: 5.71, vertikal: 2.25

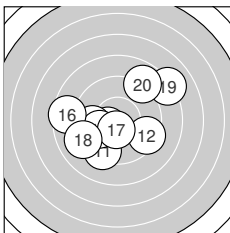

Serie 2: 93.9 (90)

9.3 ↓	9.4 ↘	10.4* ←	9.7 ←	10.0 ←
8.5 ←	10.5* ↓	9.1 ←	8.1 ↗	8.9 ↗

beste Teiler: 115.2 (17.), 134.4 (13.), 240.6 (15.)
Trefferlage: 0.60 mm links, 0.21 mm tief
Streuwert: 3.20, horizontal: 3.72, vertikal: 2.59



Ergebnis: **195.6** (188)
 Serien: 96.7 98.9
 Zähler: 10 8 2 0 0 0 0 0 0 0
 Innenzehner: 7
 Weitesten: 701 (4.), 576 (5.), 443 (2.)
 beste Teiler: 23.0 (3.), 101.3 (10.), 145.4 (18.)
 Trefferlage: 0.44 mm links, 0.20 mm tief
 Streuwert: 2.40, horizontal: 3.10, vertikal: 1.38

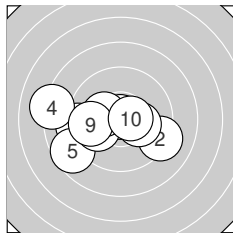
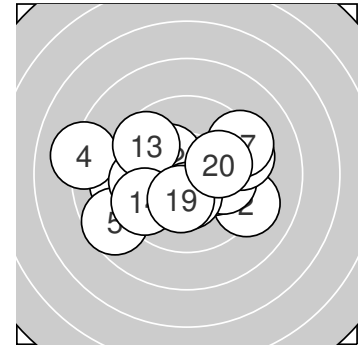

Serie 1: 96.7 (93)

9.2 ← 9.2 → 10.9* ↑
 10.0 ← 10.2* → 10.3* ←
 beste Teiler: 23.0 (3.), 101.3 (10.), 172.4 (8.)
 Trefferlage: 1.61 mm links, 0.56 mm tief
 Streuwert: 2.53, horizontal: 3.34, vertikal: 1.26

8.1 ← 8.6 ↙
 9.7 ← 10.5* →

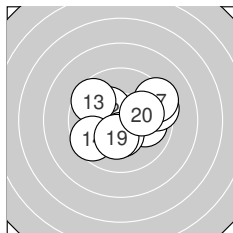

Serie 2: 98.9 (95)

9.9 → 10.3* ↘ 9.6 ↘
 9.4 → 9.3 ↗ 10.4* ↓
 beste Teiler: 145.4 (18.), 163.4 (12.), 171.9 (19.)
 Trefferlage: 0.72 mm rechts, 0.14 mm hoch
 Streuwert: 2.02, horizontal: 2.46, vertikal: 1.46

9.6 ↙ 10.0 →
 10.3* ↓ 10.1 →



Ergebnis: **174.9** (164)
 Serien: 89.6 85.3
 Zähler: 4 8 4 1 0 2 0 1 0 0 0
 Innenzehner: 4
 Weitester: 1783 (17.), 1369 (14.), 1285 (2.)
 beste Teiler: 51.6 (3.), 109.4 (13.), 130.8 (19.)
 Trefferlage: 0.72 mm links, 1.10 mm tief
 Streuwert: 5.04, horizontal: 6.46, vertikal: 3.03

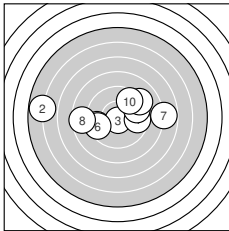
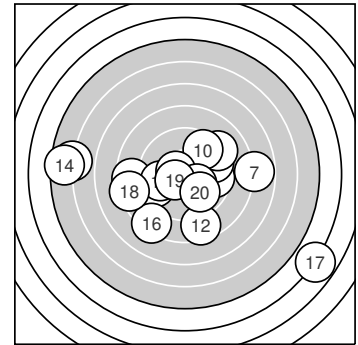

Serie 1: 89.6 (84)

9.5 ←	5.8 ←	10.7* ↓	9.6 →	9.5 →
9.5 ←	7.8 →	8.5 ←	9.1 ↗	9.6 ↗

beste Teiler: 51.6 (3.), 339.3 (4.), 344.8 (10.)
 Trefferlage: 0.53 mm links, 0.43 mm hoch
 Streuwert: 4.37, horizontal: 5.99, vertikal: 1.54

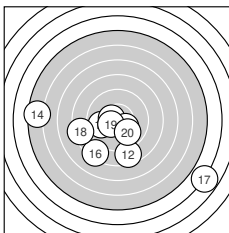

Serie 2: 85.3 (80)

9.8 ←	8.5 ↓	10.5* ←	5.5 ←	10.3* ↘
8.3 ↙	3.8 ↘	8.3 ←	10.4* ↙	9.9 ↘

beste Teiler: 109.4 (13.), 130.8 (19.), 174.1 (15.)
 Trefferlage: 0.91 mm links, 2.64 mm tief
 Streuwert: 5.65, horizontal: 7.22, vertikal: 3.42



Ergebnis: **170.2** (161)
 Serien: 88.0 82.2
 Zähler: 2 8 4 4 1 0 0 1 0 0 0
 Innenzehner: 0
 Weitester: 1770 (3.), 1126 (14.), 953 (16.)
 beste Teiler: 211.4 (8.), 222.5 (6.), 332.3 (4.)
 Trefferlage: 2.02 mm links, 1.37 mm tief
 Streuwert: 4.83, horizontal: 6.10, vertikal: 3.06

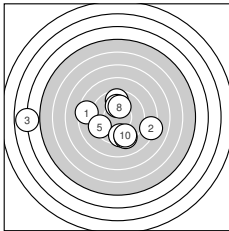
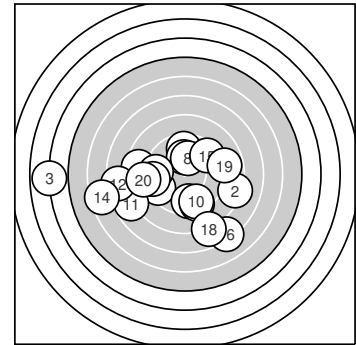

Serie 1: 88.0 (84)

8.5 ←	8.2 →	3.9 ←	9.6 ↑	9.4 ←
10.1 ↑	9.5 ↓	10.1 ↑	9.3 ↓	9.4 ↓

beste Teiler: 211.4 (8.), 222.5 (6.), 332.3 (4.)
 Trefferlage: 1.71 mm links, 0.68 mm tief
 Streuwert: 4.97, horizontal: 6.50, vertikal: 2.68

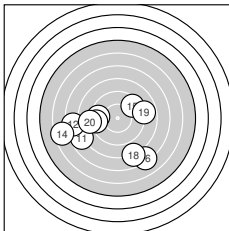

Serie 2: 82.2 (77)

7.8 ←	7.4 ←	9.4 ←	6.4 ←	9.4 ↗
7.1 ↓	9.3 ←	7.8 ↓	8.8 →	8.8 ←

beste Teiler: 378.9 (15.), 380.1 (13.), 424.6 (17.)
 Trefferlage: 2.34 mm links, 2.05 mm tief
 Streuwert: 4.88, horizontal: 6.00, vertikal: 3.40



Ergebnis: **182.4** (174)
 Serien: 91.7 90.7
 Zähler: 7 4 6 2 1 0 0 0 0 0 0
 Innenzehner: 6
 Weitester: 1151 (19.), 999 (10.), 780 (9.)
 beste Teiler: 75.0 (7.), 117.3 (18.), 121.0 (17.)
 Trefferlage: 0.22 mm rechts, 0.29 mm hoch
 Streuwert: 3.96, horizontal: 4.18, vertikal: 3.73

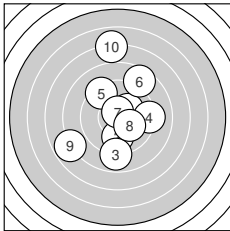
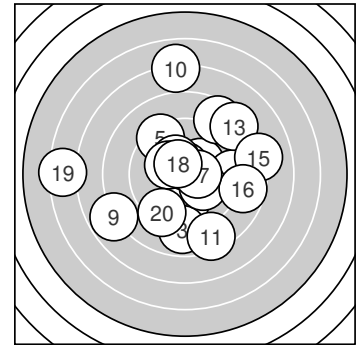

Serie 1: 91.7 (87)

10.2* ↗ 9.9 ↓ 8.9 ↓ 9.2 → 9.3 ↖
 8.6 ↗ 10.7* ↑ 10.1 ↘ 7.8 ↖ 7.0 ↑
 beste Teiler: 75.0 (7.), 180.2 (1.), 205.2 (8.)
 Trefferlage: 0.05 mm rechts, 0.72 mm hoch
 Streuwert: 3.88, horizontal: 3.08, vertikal: 4.54

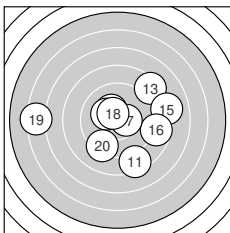

Serie 2: 90.7 (87)

8.4 ↘ 10.3* ↖ 8.4 ↗ 10.2* ↖ 8.1 →
 8.7 → 10.5* → 10.5* ↖ 6.3 ← 9.3 ↖
 beste Teiler: 117.3 (18.), 121.0 (17.), 167.5 (12.)
 Trefferlage: 0.39 mm rechts, 0.13 mm tief
 Streuwert: 4.23, horizontal: 5.23, vertikal: 2.90



Ergebnis: **142.2** (133)
 Serien: 67.6 74.6
 Zähler: 1 3 5 3 2 3 1 1 0 1 0
 Innenzehner: 1
 Weitester: 2277 (8.), 1901 (10.), 1696 (14.)
 beste Teiler: 181.1 (17.), 251.2 (3.), 336.0 (12.)
 Trefferlage: 0.69 mm rechts, 1.56 mm hoch
 Streuwert: 7.93, horizontal: 7.46, vertikal: 8.37

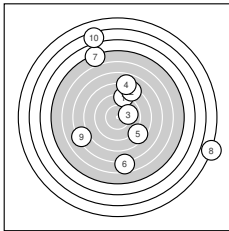
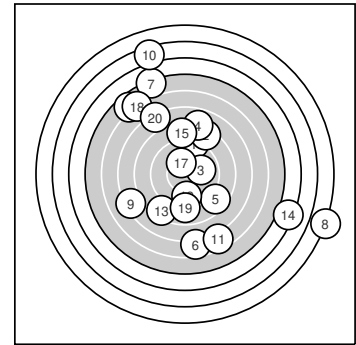

Serie 1: 67.6 (63)

9.0 ↗ 8.3 ↗ 9.9 →
 6.6 ↓ 5.0 ↖ 1.8 →

beste Teiler: 251.2 (3.), 481.6 (1.), 600.5 (5.)
 Trefferlage: 1.78 mm rechts, 2.42 mm hoch
 Streuwert: 8.78, horizontal: 8.17, vertikal: 9.34

7.9 ↗ 8.6 ↘
 7.2 ↙ 3.3 ↖

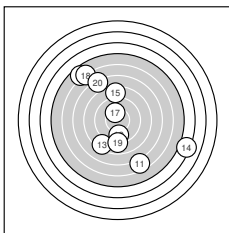

Serie 2: 74.6 (70)

6.5 ↘ 9.6 ↓ 8.3 ↘
 5.6 ↖ 10.2* ↖ 5.9 ↖

beste Teiler: 181.1 (17.), 336.0 (12.), 513.0 (19.)
 Trefferlage: 0.39 mm links, 0.71 mm hoch
 Streuwert: 7.31, horizontal: 6.94, vertikal: 7.67

4.2 → 8.4 ↑
 8.9 ↓ 7.0 ↖



ISSF AR 40

Jungschützinnen

StartNr: 226

StandNr: 9

Competition

12.10.2024 13:13

ECKMAIER, Klara #7789

Priv. SG Mariazell / Priv. SG Mariazell

Ergebnis: **0.0** (0)_{DNS}
Serien:
Zähler: 0 0 0 0 0 0 0 0 0 0 0
Innenzehner: 0
Weiteste:
~~beste Teiler~~
Trefferlage: 0.00 mm , 0.00 mm
Streuwert:

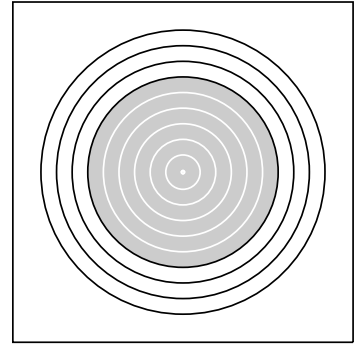

Ergebnis: **402.5** (386)
 Serien: 101.8 101.0 102.7 97.0
 Zähler: 28 10 2 0 0 0 0 0 0 0
 Innenzehner: 20
 Weitester: 574 (20.), 534 (38.), 452 (26.)
 beste Teiler: 16.2 (24.), 33.5 (21.), 36.0 (6.)
 Trefferlage: 0.27 mm links, 0.00 mm
 Streuwert: 1.85, horizontal: 2.05, vertikal: 1.62

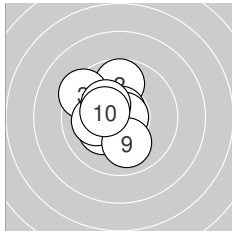
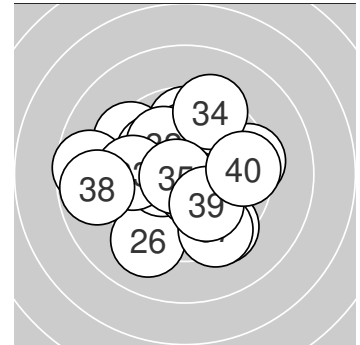

Serie 1: 101.8 (98)

10.2* ←	9.7 ↑	9.4 ↖	10.7* ↑	10.2* ↙
10.8* →	10.1 ←	10.3* ↘	10.0 ↓	10.4* ↖

beste Teiler: 36.0 (6.), 56.8 (4.), 143.0 (10.)
 Trefferlage: 1.02 mm links, 0.39 mm hoch
 Streuwert: 1.39, horizontal: 1.26, vertikal: 1.51

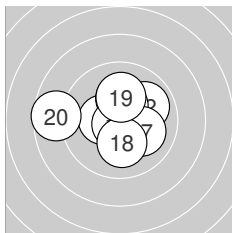

Serie 2: 101.0 (97)

10.4* ←	9.9 ↗	10.2* ↑	10.3* ↘	10.4* ↑
10.8* ↙	10.1 ↘	10.1 ↓	10.1 ↑	8.7 ←

beste Teiler: 43.6 (16.), 133.8 (15.), 148.0 (11.)
 Trefferlage: 0.11 mm links, 0.28 mm hoch
 Streuwert: 1.86, horizontal: 2.26, vertikal: 1.36

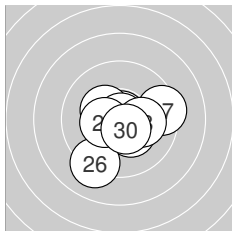

Serie 3: 102.7 (98)

10.8* ↑	10.8* ←	10.3* ↖	10.9* ↗	10.3* ↘
9.1 ↙	9.4 →	10.2* →	10.4* ←	10.5* ↘

beste Teiler: 16.2 (24.), 33.5 (21.), 39.2 (22.)
 Trefferlage: 0.23 mm rechts, 0.46 mm tief
 Streuwert: 1.58, horizontal: 1.76, vertikal: 1.38

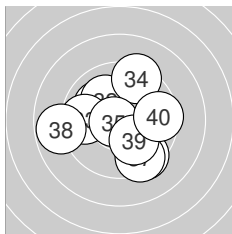

Serie 4: 97.0 (93)

10.0 ↖	10.1 ↘	9.7 ←	9.3 ↑	10.7* ←
9.4 ↘	9.4 ↘	8.8 ←	10.1 ↘	9.5 →

beste Teiler: 53.1 (35.), 221.2 (39.), 222.5 (32.)
 Trefferlage: 0.17 mm links, 0.19 mm tief
 Streuwert: 2.48, horizontal: 2.74, vertikal: 2.20



Ergebnis: **405.1** (387)
 Serien: 104.5 99.9 98.5 102.2
 Zähler: 28 11 1 0 0 0 0 0 0 0 0
 Innenzehner: 21
 Weitestе: 527 (25.), 457 (15.), 447 (17.)
 beste Teiler: 17.0 (3.), 38.3 (35.), 48.1 (1.)
 Trefferlage: 0.08 mm links, 0.49 mm hoch
 Streuwert: 1.69, horizontal: 1.91, vertikal: 1.45

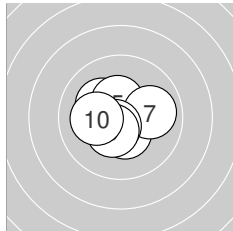
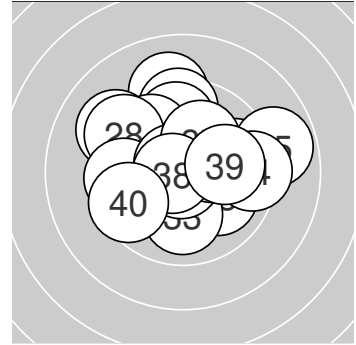

Serie 1: 104.5 (100)

10.8* ↖	10.2* ↘	10.9* →	10.7* ↑	10.4* ↑
10.4* ↓	10.0 →	10.6* ↙	10.4* ↘	10.1 ←

beste Teiler: 17.0 (3.), 48.1 (1.), 75.0 (4.)
 Trefferlage: 0.22 mm links, 0.07 mm hoch
 Streuwert: 1.06, horizontal: 1.21, vertikal: 0.89

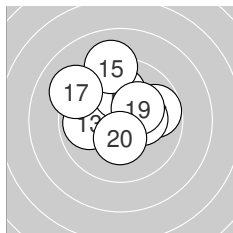

Serie 2: 99.9 (96)

10.7* ↖	10.4* ↑	9.9 ←	10.0 ↑	9.1 ↑
9.8 →	9.2 ↘	10.3* →	10.2* ↗	10.3* ↓

beste Teiler: 70.2 (11.), 138.7 (12.), 151.0 (20.)
 Trefferlage: 0.14 mm links, 1.12 mm hoch
 Streuwert: 1.83, horizontal: 1.99, vertikal: 1.66

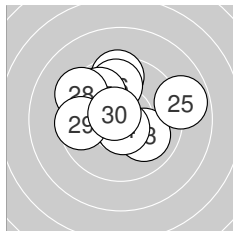

Serie 3: 98.5 (93)

10.3* ←	9.5 ↑	10.0 ↘	10.6* ↓	8.8 →
9.8 ↑	9.8 ↘	9.4 ↘	9.6 ←	10.7* ↘

beste Teiler: 69.4 (30.), 77.8 (24.), 157.3 (21.)
 Trefferlage: 0.39 mm links, 1.04 mm hoch
 Streuwert: 2.11, horizontal: 2.50, vertikal: 1.63

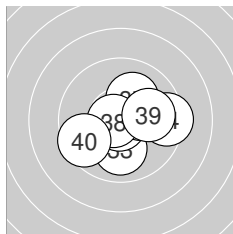

Serie 4: 102.2 (98)

10.7* ↙	10.7* ←	10.0 ↓	9.4 →	10.8* ↓
10.3* →	10.1 ↗	10.7* ←	10.0 →	9.5 ↙

beste Teiler: 38.3 (35.), 51.2 (32.), 60.4 (38.)
 Trefferlage: 0.43 mm rechts, 0.24 mm tief
 Streuwert: 1.58, horizontal: 1.91, vertikal: 1.16



Ergebnis: **410.8** (390)
 Serien: 104.3 103.5 99.9 103.1
 Zähler: 31 8 1 0 0 0 0 0 0 0
 Innenzehner: 27
 Weitester: 511 (12.), 395 (26.), 350 (24.)
 beste Teiler: 8.9 (16.), 28.4 (6.), 36.4 (35.)
 Trefferlage: 0.88 mm rechts, 0.08 mm tief
 Streuwert: 1.33, horizontal: 1.63, vertikal: 0.93

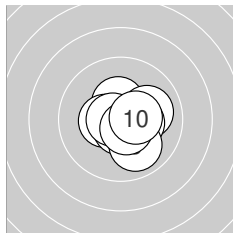
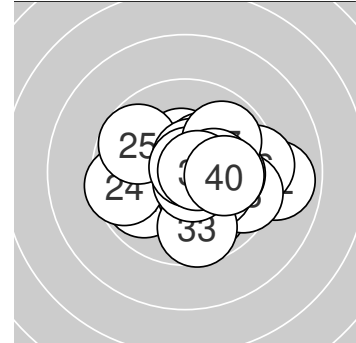

Serie 1: 104.3 (100)

10.4* ↑	10.0 →	10.4* →	10.4* ←	10.6* ↓
10.8* ↘	10.7* ←	10.0 ↘	10.6* ↘	10.4* →

beste Teiler: 28.4 (6.), 67.0 (7.), 77.5 (5.)
 Trefferlage: 0.46 mm rechts, 0.22 mm tief
 Streuwert: 1.01, horizontal: 1.09, vertikal: 0.92

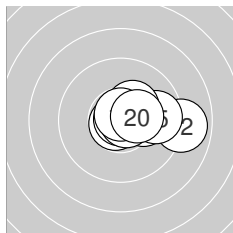

Serie 2: 103.5 (97)

10.6* ↗	8.9 →	10.2* →	10.7* ↖	9.8 →
10.9* ↘	10.4* ↗	10.8* →	10.8* ↑	10.4* →

beste Teiler: 8.9 (16.), 48.0 (19.), 48.6 (18.)
 Trefferlage: 1.31 mm rechts, 0.21 mm hoch
 Streuwert: 1.23, horizontal: 1.67, vertikal: 0.46

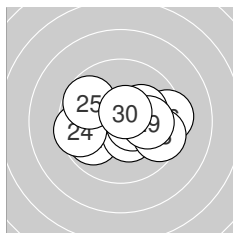

Serie 3: 99.9 (95)

9.9 ↖	10.4* ↘	10.5* →	9.6 ←	9.7 ↘
9.4 →	10.2* ↗	9.6 →	10.0 →	10.6* ↗

beste Teiler: 86.7 (30.), 105.5 (23.), 138.9 (22.)
 Trefferlage: 0.50 mm rechts, 0.13 mm tief
 Streuwert: 1.93, horizontal: 2.53, vertikal: 1.02

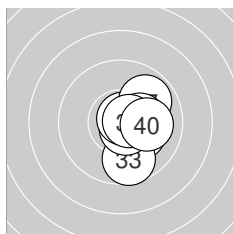

Serie 4: 103.1 (98)

10.4* →	10.2* ↘	9.7 ↓	10.7* ↘	10.8* ↗
10.3* →	9.9 ↗	10.3* →	10.7* →	10.1 →

beste Teiler: 36.4 (35.), 70.4 (34.), 71.5 (39.)
 Trefferlage: 1.24 mm rechts, 0.18 mm tief
 Streuwert: 1.01, horizontal: 0.69, vertikal: 1.24



Ergebnis: **411.1** (393)
 Serien: 103.3 104.5 104.2 99.1
 Zähler: 33 7 0 0 0 0 0 0 0 0
 Innenzehner: 26
 Weitester: 407 (39.), 350 (1.), 337 (32.)
 beste Teiler: 14.0 (6.), 23.5 (5.), 28.1 (20.)
 Trefferlage: 0.02 mm rechts, 0.81 mm hoch
 Streuwert: 1.26, horizontal: 1.43, vertikal: 1.05

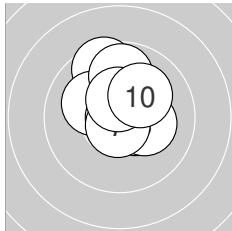
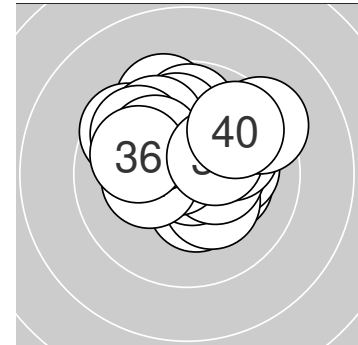

Serie 1: 103.3 (98)

9.6 ↗	10.5* ↘	10.2* →	10.1 ↖	10.9* ↑
10.9* ←	10.7* ↓	9.8 ↑	10.5* ↑	10.1 ↘

beste Teiler: 14.0 (6.), 23.5 (5.), 56.5 (7.)
 Trefferlage: 0.10 mm rechts, 0.87 mm hoch
 Streuwert: 1.24, horizontal: 1.09, vertikal: 1.38

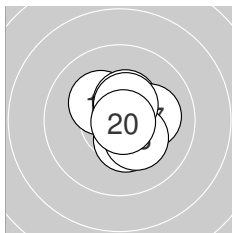

Serie 2: 104.5 (100)

10.6* ↗	10.8* →	10.2* ↘	10.4* ↓	10.4* ↑
10.4* →	10.1 →	10.3* ↘	10.5* ↑	10.8* ↘

beste Teiler: 28.1 (20.), 50.9 (12.), 89.4 (11.)
 Trefferlage: 0.57 mm rechts, 0.20 mm hoch
 Streuwert: 0.91, horizontal: 0.88, vertikal: 0.94

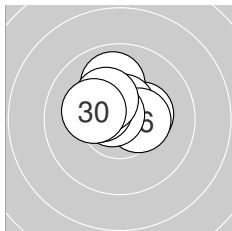

Serie 3: 104.2 (100)

10.5* ↖	10.3* →	10.0 ↑	10.8* ↑	10.6* ↑
10.4* →	10.7* ↖	10.4* ↖	10.3* ↖	10.2* ↖

beste Teiler: 49.0 (24.), 60.7 (27.), 91.9 (25.)
 Trefferlage: 0.28 mm links, 0.75 mm hoch
 Streuwert: 0.92, horizontal: 1.09, vertikal: 0.70

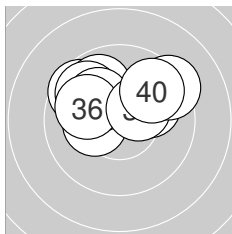

Serie 4: 99.1 (95)

10.3* ←	9.6 ↖	9.9 ↖	9.8 ↖	10.1 ↖
10.0 ↖	10.1 ↗	10.3* ↗	9.3 ↗	9.7 ↗

beste Teiler: 153.4 (38.), 173.9 (31.), 204.4 (35.)
 Trefferlage: 0.28 mm links, 1.43 mm hoch
 Streuwert: 1.70, horizontal: 2.27, vertikal: 0.82



Ergebnis: **395.8** (377)
 Serien: 98.3 102.4 97.1 98.0
 Zähler: 19 19 2 0 0 0 0 0 0 0
 Innenzehner: 15
 Weitester: 615 (29.), 502 (9.), 486 (24.)
 beste Teiler: 26.4 (19.), 41.0 (21.), 89.3 (17.)
 Trefferlage: 0.31 mm rechts, 0.57 mm hoch
 Streuwert: 2.07, horizontal: 2.44, vertikal: 1.62

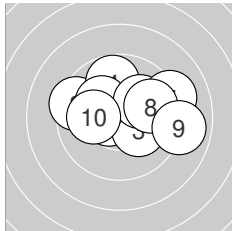
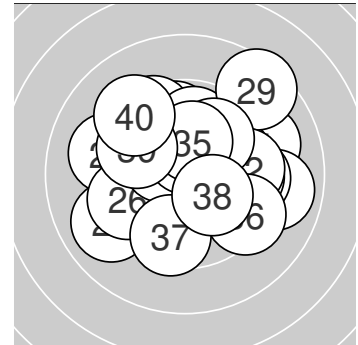

Serie 1: 98.3 (94)

10.6* ←	9.4 ↖	10.2* ↘	9.8 ↑	10.2* ↘
10.1 ↗	9.2 ↗	9.8 →	8.9 →	10.1 ←

beste Teiler: 89.4 (1.), 188.6 (3.), 190.3 (5.)
 Trefferlage: 0.62 mm rechts, 0.71 mm hoch
 Streuwert: 2.17, horizontal: 2.82, vertikal: 1.22

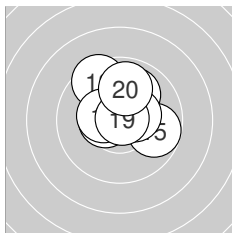

Serie 2: 102.4 (97)

10.5* ←	9.5 ↖	10.0 ↗	10.5* ↑	9.8 →
10.4* →	10.6* ↑	10.4* ←	10.8* ↗	9.9 ↑

beste Teiler: 26.4 (19.), 89.3 (17.), 118.1 (11.)
 Trefferlage: 0.16 mm rechts, 1.01 mm hoch
 Streuwert: 1.34, horizontal: 1.39, vertikal: 1.28

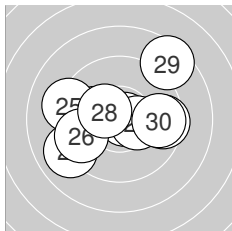

Serie 3: 97.1 (93)

10.8* →	9.5 →	10.1 ←	9.0 ↖	9.2 ←
9.6 ↖	10.4* →	10.4* ↖	8.5 ↗	9.6 →

beste Teiler: 41.0 (21.), 141.4 (28.), 149.2 (27.)
 Trefferlage: 0.21 mm links, 0.23 mm hoch
 Streuwert: 2.63, horizontal: 3.20, vertikal: 1.90

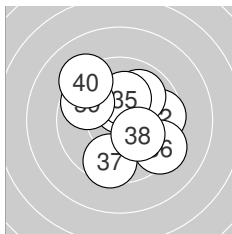

Serie 4: 98.0 (93)

9.8 →	9.6 →	10.5* ↑	9.9 ↗	10.2* ↑
9.3 ↘	9.6 ↓	10.2* ↘	9.7 ↖	9.2 ↘

beste Teiler: 113.2 (33.), 185.3 (35.), 192.6 (38.)
 Trefferlage: 0.68 mm rechts, 0.35 mm hoch
 Streuwert: 2.17, horizontal: 2.27, vertikal: 2.06



Ergebnis: **391.1** (374)
 Serien: 95.1 98.6 100.2 97.2
 Zähler: 16 22 2 0 0 0 0 0 0 0 0
 Innenezehner: 12
 Weitester: 577 (33.), 534 (1.), 485 (37.)
 beste Teiler: 25.9 (25.), 61.0 (2.), 88.4 (18.)
 Trefferlage: 0.93 mm links, 0.09 mm tief
 Streuwert: 2.23, horizontal: 2.69, vertikal: 1.65

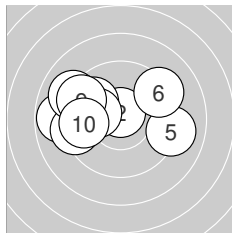
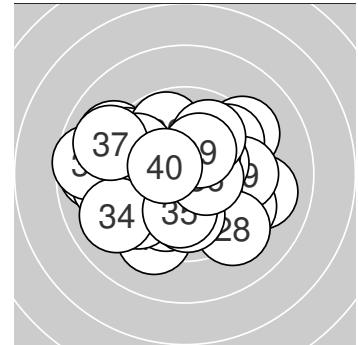

Serie 1: 95.1 (91)

8.8 ←	10.7* ↑	9.3 ←	9.0 ↖	9.1 →
9.3 ↗	9.8 ↘	10.1 ←	9.4 ↖	9.6 ←

beste Teiler: 61.0 (2.), 222.1 (8.), 288.7 (7.)
 Trefferlage: 1.71 mm links, 0.68 mm hoch
 Streuwert: 2.53, horizontal: 3.34, vertikal: 1.26

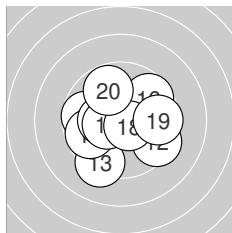

Serie 2: 98.6 (93)

9.7 ←	9.4 ↘	9.3 ↓	9.8 ←	10.3* ←
9.7 ↗	10.4* ←	10.6* ↘	9.6 →	9.8 ↗

beste Teiler: 88.4 (18.), 127.2 (17.), 164.0 (15.)
 Trefferlage: 0.18 mm links, 0.27 mm tief
 Streuwert: 2.17, horizontal: 2.47, vertikal: 1.84

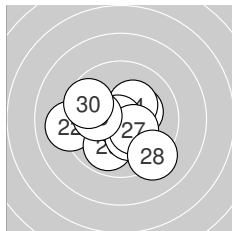

Serie 3: 100.2 (96)

10.3* ↗	9.1 ←	9.9 ↓	10.3* ↗	10.9* ←
10.3* ↘	10.4* ↘	9.2 ↘	10.1 ←	9.7 ↘

beste Teiler: 25.9 (25.), 149.4 (27.), 168.2 (26.)
 Trefferlage: 0.34 mm links, 0.50 mm tief
 Streuwert: 1.96, horizontal: 2.31, vertikal: 1.54

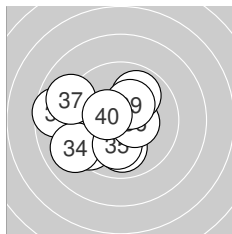

Serie 4: 97.2 (94)

10.0 ↓	9.5 ↙	8.6 ←	9.0 ↙	10.1 ↓
10.4* →	9.0 ↖	9.9 ↗	10.3* ↗	10.4* ↖

beste Teiler: 129.8 (36.), 130.5 (40.), 165.4 (39.)
 Trefferlage: 1.49 mm links, 0.28 mm tief
 Streuwert: 2.28, horizontal: 2.61, vertikal: 1.90



Ergebnis: **397.7** (378)
 Serien: 98.3 98.1 101.5 99.8
 Zähler: 20 18 2 0 0 0 0 0 0 0
 Innenzehner: 15
 Weitester: 579 (2.), 510 (19.), 435 (40.)
 beste Teiler: 5.0 (29.), 33.5 (21.), 63.0 (8.)
 Trefferlage: 0.76 mm rechts, 0.23 mm tief
 Streuwert: 1.98, horizontal: 2.07, vertikal: 1.87

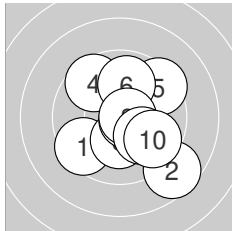
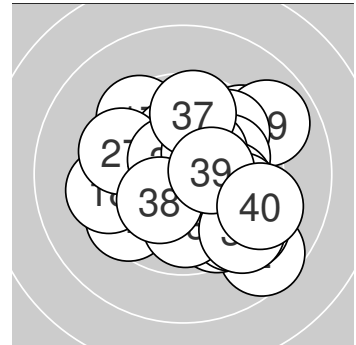

Serie 1: 98.3 (93)

9.5 ↙	8.6 ↘	10.2* ↓	9.6 ↖	9.4 ↗
9.9 ↑	10.7* ↘	10.7* →	10.0 ↘	9.7 ↘

beste Teiler: 63.0 (8.), 66.7 (7.), 177.0 (3.)
 Trefferlage: 0.83 mm rechts, 0.38 mm tief
 Streuwert: 2.24, horizontal: 2.16, vertikal: 2.31

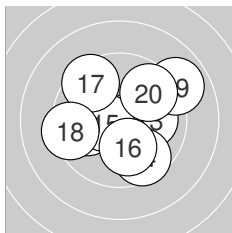

Serie 2: 98.1 (93)

9.9 ←	10.5* →	10.0 →	9.6 ↘	10.5* ←
10.1 ↓	9.5 ↖	9.4 ←	8.9 ↗	9.7 ↗

beste Teiler: 112.9 (15.), 116.1 (12.), 219.8 (16.)
 Trefferlage: 0.27 mm rechts, 0.12 mm hoch
 Streuwert: 2.30, horizontal: 2.61, vertikal: 1.93

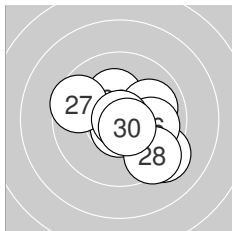

Serie 3: 101.5 (97)

10.8* ↖	10.3* ↑	10.0 →	9.2 ↘	10.7* ↓
10.0 →	9.6 ↖	9.4 ↘	10.9* →	10.6* ↘

beste Teiler: 5.0 (29.), 33.5 (21.), 72.1 (25.)
 Trefferlage: 0.73 mm rechts, 0.34 mm tief
 Streuwert: 1.74, horizontal: 1.95, vertikal: 1.50

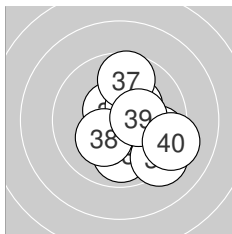

Serie 4: 99.8 (95)

10.5* ↑	10.6* ↖	9.9 ↓	9.7 ↘	10.3* ↗
9.3 ↘	9.7 ↑	10.2* ↗	10.4* →	9.2 ↘

beste Teiler: 99.3 (32.), 120.0 (31.), 149.2 (39.)
 Trefferlage: 1.19 mm rechts, 0.33 mm tief
 Streuwert: 1.81, horizontal: 1.70, vertikal: 1.91



Ergebnis: **402.9** (388)
 Serien: 102.3 99.5 99.1 102.0
 Zähler: 29 10 1 0 0 0 0 0 0 0
 Innenzehner: 19
 Weitester: 570 (16.), 498 (21.), 416 (29.)
 beste Teiler: 35.1 (25.), 57.5 (2.), 62.8 (37.)
 Trefferlage: 0.37 mm rechts, 0.03 mm tief
 Streuwert: 1.76, horizontal: 1.85, vertikal: 1.66

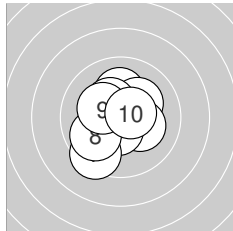
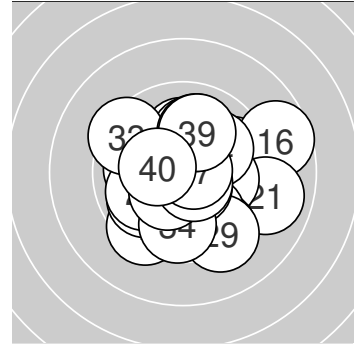

Serie 1: 102.3 (98)

10.1 ↑	10.7* ↑	10.2* ↗	10.2* →	10.4* ↘
10.5* ↓	9.4 ↙	9.9 ↘	10.3* ↖	10.6* ↗

beste Teiler: 57.5 (2.), 95.4 (10.), 111.8 (6.)
 Trefferlage: 0.29 mm links, 0.03 mm tief
 Streuwert: 1.49, horizontal: 1.41, vertikal: 1.58

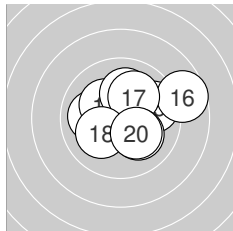

Serie 2: 99.5 (97)

10.0 ←	10.2* ↘	10.2* ↗	10.1 ↑	9.8 →
8.7 →	10.1 ↑	10.1 ↙	10.1 ↘	10.2* ↘

beste Teiler: 180.8 (12.), 188.1 (20.), 189.8 (13.)
 Trefferlage: 0.85 mm rechts, 0.57 mm hoch
 Streuwert: 1.91, horizontal: 2.29, vertikal: 1.41

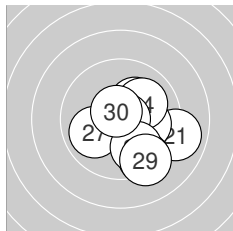

Serie 3: 99.1 (95)

9.0 →	10.1 →	10.2* ↗	10.0 ↗	10.8* →
9.4 ↘	9.9 ↙	9.8 ↘	9.3 ↘	10.6* ↘

beste Teiler: 35.1 (25.), 78.2 (30.), 187.7 (23.)
 Trefferlage: 1.33 mm rechts, 0.87 mm tief
 Streuwert: 1.83, horizontal: 1.85, vertikal: 1.81

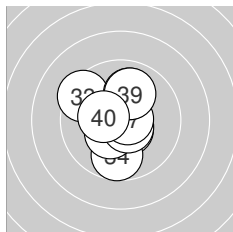

Serie 4: 102.0 (98)

10.5* ↘	10.4* ↖	9.4 ↖	9.7 ↓	10.4* ↙
10.6* ↘	10.7* →	10.0 ↑	10.0 ↑	10.3* ↖

beste Teiler: 62.8 (37.), 87.6 (36.), 103.8 (31.)
 Trefferlage: 0.37 mm links, 0.19 mm hoch
 Streuwert: 1.54, horizontal: 1.34, vertikal: 1.71



Ergebnis: **386.0** (369)
 Serien: 96.3 95.7 94.4 99.6
 Zähler: 16 18 5 1 0 0 0 0 0 0
 Innenzehner: 12
 Weitester: 805 (24.), 733 (26.), 633 (36.)
 beste Teiler: 47.0 (7.), 72.0 (32.), 117.8 (30.)
 Trefferlage: 0.28 mm rechts, 0.09 mm hoch
 Streuwert: 2.65, horizontal: 3.19, vertikal: 1.96

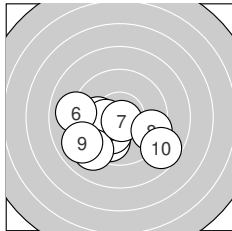
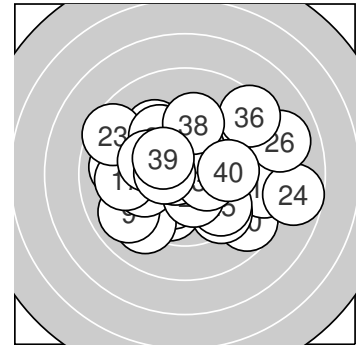

Serie 1: 96.3 (93)

10.0 ← 9.8 ↙ 10.2* ↘ 10.3* ← 9.1 ↗
 9.0 ← 10.8* ↘ 9.4 → 9.0 ↗ 8.7 ↘
 beste Teiler: 47.0 (7.), 153.7 (4.), 197.6 (3.)
 Trefferlage: 0.93 mm links, 1.57 mm tief
 Streuwert: 2.38, horizontal: 3.02, vertikal: 1.47

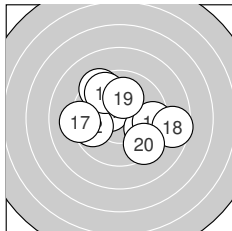

Serie 2: 95.7 (91)

10.4* ↘ 9.7 ← 9.4 ↘ 9.7 ↘ 9.8 ↘
 9.5 → 9.2 ← 8.6 → 10.0 ↑ 9.4 ↘
 beste Teiler: 138.1 (11.), 226.5 (19.), 293.2 (15.)
 Trefferlage: 0.29 mm rechts, 0.23 mm hoch
 Streuwert: 2.70, horizontal: 3.28, vertikal: 1.94

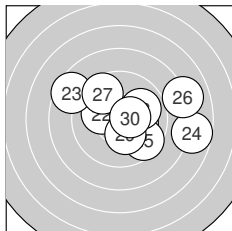

Serie 3: 94.4 (90)

10.1 → 10.1 ← 8.6 ↘ 7.7 → 9.6 ↘
 8.0 → 9.6 ↘ 9.9 → 10.3* ↘ 10.5* →
 beste Teiler: 117.8 (30.), 173.8 (29.), 203.3 (21.)
 Trefferlage: 1.44 mm rechts, 0.42 mm hoch
 Streuwert: 3.11, horizontal: 3.98, vertikal: 1.88

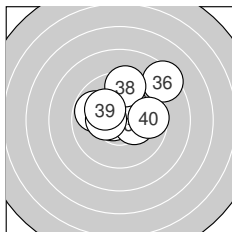

Serie 4: 99.6 (95)

10.2* ↑ 10.7* ← 10.4* ↘ 9.8 ← 10.3* →
 8.4 ↗ 10.4* ← 9.5 ↑ 10.2* ↘ 9.7 →
 beste Teiler: 72.0 (32.), 140.8 (33.), 149.1 (37.)
 Trefferlage: 0.33 mm rechts, 1.27 mm hoch
 Streuwert: 1.97, horizontal: 2.31, vertikal: 1.57



Ergebnis: **398.4** (379)
 Serien: 99.4 100.8 100.5 97.7
 Zähler: 22 15 3 0 0 0 0 0 0 0
 Innenezehner: 17
 Weitester: 586 (37.), 537 (22.), 511 (24.)
 beste Teiler: 43.9 (29.), 74.0 (23.), 74.1 (36.)
 Trefferlage: 0.00 mm , 0.11 mm tief
 Streuwert: 2.04, horizontal: 2.09, vertikal: 1.98

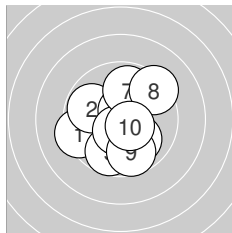
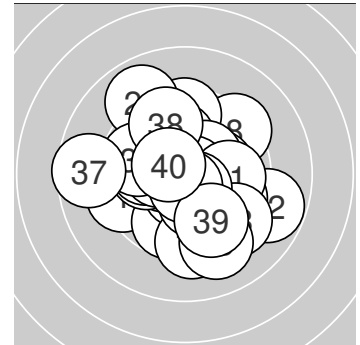

Serie 1: 99.4 (94)

9.4 ←	9.8 ↖	10.6* ↑	10.0 ↘	9.7 ↓
10.5* ↓	9.9 ↑	9.3 ↗	9.7 ↓	10.5* ↘

beste Teiler: 82.0 (3.), 103.8 (10.), 106.9 (6.)
 Trefferlage: 0.05 mm links, 0.34 mm tief
 Streuwert: 2.03, horizontal: 1.99, vertikal: 2.06

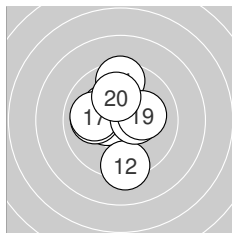

Serie 2: 100.8 (98)

10.5* ←	9.3 ↓	10.0 ←	9.5 ↑	10.5* ↑
10.3* ↖	10.0 ←	10.4* →	10.2* →	10.1 ↑

beste Teiler: 109.8 (15.), 123.1 (11.), 130.1 (18.)
 Trefferlage: 0.37 mm links, 0.46 mm hoch
 Streuwert: 1.73, horizontal: 1.45, vertikal: 1.97

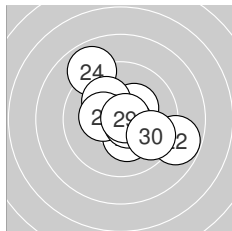

Serie 3: 100.5 (95)

10.3* ↗	8.8 ↘	10.7* ↓	8.9 ↖	10.1 ↖
10.3* ↓	10.3* ←	10.6* ↘	10.8* →	9.7 ↘

beste Teiler: 43.9 (29.), 74.0 (23.), 81.8 (28.)
 Trefferlage: 0.55 mm rechts, 0.12 mm hoch
 Streuwert: 2.05, horizontal: 2.20, vertikal: 1.89

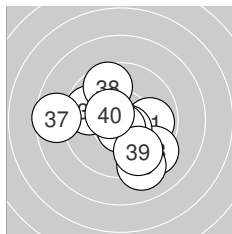

Serie 4: 97.7 (92)

9.9 →	9.8 ↖	9.3 ↘	10.5* ↓	9.1 ↓
10.7* ↓	8.6 ←	9.6 ↖	9.7 ↓	10.5* ↖

beste Teiler: 74.1 (36.), 106.2 (34.), 115.1 (40.)
 Trefferlage: 0.10 mm links, 0.68 mm tief
 Streuwert: 2.45, horizontal: 2.75, vertikal: 2.11



Ergebnis: **409.4** (392)
 Serien: 100.4 102.3 102.8 103.9
 Zähler: 32 8 0 0 0 0 0 0 0 0
 Innenzehner: 26
 Weitester: 491 (8.), 443 (23.), 364 (6.)
 beste Teiler: 6.7 (34.), 14.0 (35.), 34.6 (22.)
 Trefferlage: 0.14 mm rechts, 0.00 mm
 Streuwert: 1.50, horizontal: 1.79, vertikal: 1.15

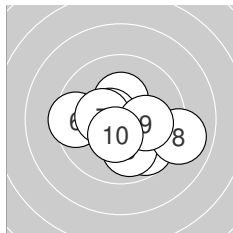
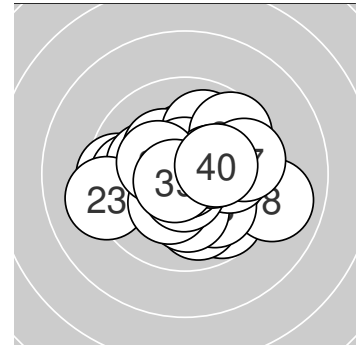

Serie 1: 100.4 (97)

10.4* ↘	10.3* ↑	9.7 ↘	10.6* ←	10.0 ↓
9.5 ←	10.4* ←	9.0 →	10.1 →	10.4* ↓

beste Teiler: 91.0 (4.), 126.2 (1.), 132.1 (10.)
 Trefferlage: 0.40 mm rechts, 0.64 mm tief
 Streuwert: 1.83, horizontal: 2.27, vertikal: 1.24

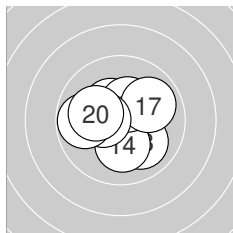

Serie 2: 102.3 (98)

10.6* ←	10.5* ↘	10.0 ↘	10.2* ↓	10.4* ↖
10.4* ↑	9.9 ↗	10.4* ←	9.8 ←	10.1 ←

beste Teiler: 93.3 (11.), 122.4 (12.), 140.1 (16.)
 Trefferlage: 0.24 mm links, 0.05 mm tief
 Streuwert: 1.43, horizontal: 1.64, vertikal: 1.17

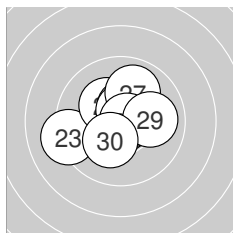

Serie 3: 102.8 (99)

10.4* ←	10.8* ↘	9.2 ←	10.3* ↖	10.5* ↑
10.6* ↑	10.0 ↑	10.7* →	10.0 →	10.3* ↓

beste Teiler: 34.6 (22.), 52.0 (28.), 92.1 (26.)
 Trefferlage: 0.27 mm links, 0.27 mm hoch
 Streuwert: 1.50, horizontal: 1.77, vertikal: 1.18

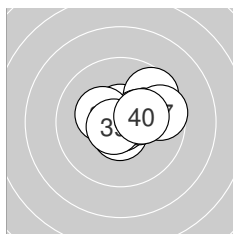

Serie 4: 103.9 (98)

10.6* ↑	10.6* ↓	9.6 ↗	10.9* ↘	10.9* ↓
10.4* →	9.6 →	10.3* ←	10.7* ↖	10.3* →

beste Teiler: 6.7 (34.), 14.0 (35.), 66.2 (39.)
 Trefferlage: 0.67 mm rechts, 0.39 mm hoch
 Streuwert: 1.19, horizontal: 1.46, vertikal: 0.83



ISSF AR 40

StandNr: 8

CERMAK, Romina #765

Juniorinnen

Competition

StartNr: 322

12.10.2024 13:14

SV Knittelfeld

Ergebnis: **0.0** (0)_{DNS}
Serien:
Zähler: 0 0 0 0 0 0 0 0 0 0 0
Innenzehner: 0
Weiteste:
~~beste Teiler~~
Trefferlage: 0.00 mm , 0.00 mm
Streuwert:

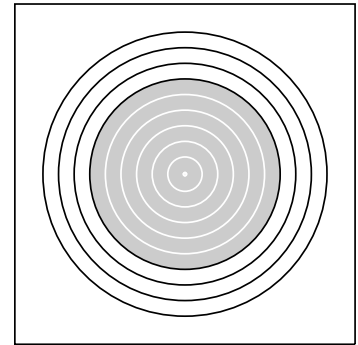

Ergebnis: **377.4** (360)
 Serien: 90.6 93.8 94.5 98.5
 Zähler: 12 20 5 2 1 0 0 0 0 0
 Innenzehner: 9
 Weitester: 1029 (3.), 879 (20.), 859 (26.)
 beste Teiler: 47.2 (33.), 49.0 (38.), 97.0 (17.)
 Trefferlage: 0.25 mm rechts, 0.91 mm hoch
 Streuwert: 3.09, horizontal: 3.69, vertikal: 2.35

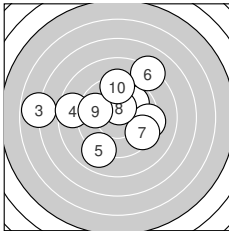
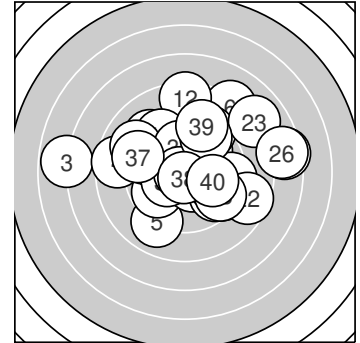

Serie 1: 90.6 (86)

9.9 ↗	9.3 →	6.8 ←	8.6 ←	9.0 ↘
8.2 ↗	9.4 ↘	10.4* ↑	9.7 ←	9.3 ↑

beste Teiler: 127.7 (8.), 263.0 (1.), 302.7 (9.)
 Trefferlage: 0.82 mm links, 0.87 mm hoch
 Streuwert: 3.82, horizontal: 4.62, vertikal: 2.80

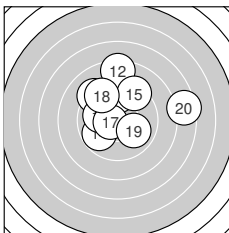

Serie 2: 93.8 (90)

9.7 ↑	8.4 ↑	9.2 ↘	9.8 ↗	9.3 ↗
10.0 ←	10.6* ←	9.4 ↘	10.0 ↘	7.4 →

beste Teiler: 97.0 (17.), 236.2 (16.), 248.2 (19.)
 Trefferlage: 0.23 mm rechts, 1.84 mm hoch
 Streuwert: 3.04, horizontal: 3.47, vertikal: 2.54

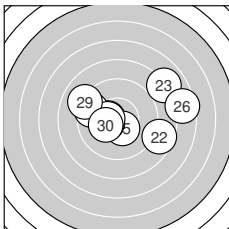

Serie 3: 94.5 (91)

10.4* ←	8.6 ↘	8.0 ↗	9.5 ←	10.4* ↘
7.5 →	10.4* ←	10.4* ←	9.0 ←	10.3* ←

beste Teiler: 126.7 (21.), 130.0 (28.), 135.5 (25.)
 Trefferlage: 0.73 mm rechts, 0.50 mm hoch
 Streuwert: 3.35, horizontal: 4.33, vertikal: 1.93

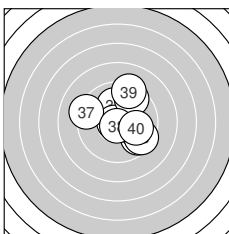

Serie 4: 98.5 (93)

9.6 ↘	10.0 ↑	10.8* ←	9.9 →	9.6 ↗
9.5 ↘	9.2 ←	10.8* ↓	9.2 ↑	9.9 →

beste Teiler: 47.2 (33.), 49.0 (38.), 226.7 (32.)
 Trefferlage: 0.86 mm rechts, 0.42 mm hoch
 Streuwert: 2.14, horizontal: 2.18, vertikal: 2.11



Ergebnis: **361.4** (339)
 Serien: 89.6 93.4 94.2 84.2
 Zähler: 7 17 8 6 1 0 1 0 0 0 0
 Innenezehner: 6
 Weitester: 1640 (34.), 1145 (31.), 953 (36.)
 beste Teiler: 30.6 (40.), 44.3 (28.), 57.4 (18.)
 Trefferlage: 2.27 mm rechts, 1.37 mm hoch
 Streuwert: 3.66, horizontal: 4.47, vertikal: 2.61

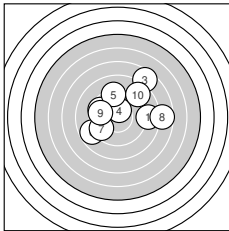
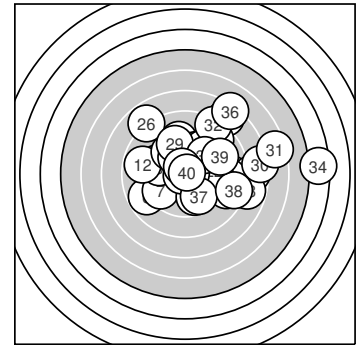

Serie 1: 89.6 (84)

8.7 →	9.5 ↖	7.5 ↗	10.4* ↑	9.2 ↑
8.8 ↙	9.5 ↘	7.7 →	9.6 ↖	8.7 ↗

beste Teiler: 131.2 (4.), 326.9 (9.), 351.9 (2.)
 Trefferlage: 0.80 mm rechts, 1.41 mm hoch
 Streuwert: 3.82, horizontal: 4.52, vertikal: 2.96

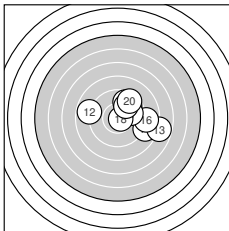

Serie 2: 93.4 (86)

8.8 ↘	8.8 ↖	7.8 →	9.6 ↗	9.7 ↗
8.8 →	9.9 ↗	10.7* →	9.9 ↗	9.4 ↗

beste Teiler: 57.4 (18.), 261.3 (17.), 268.7 (19.)
 Trefferlage: 2.30 mm rechts, 0.83 mm hoch
 Streuwert: 2.77, horizontal: 3.42, vertikal: 1.91

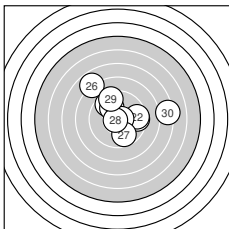

Serie 3: 94.2 (89)

9.5 →	9.5 →	9.6 ↖	10.0 ↖	10.7* →
7.8 ↖	9.7 ↘	10.8* ↖	9.4 ↖	7.2 →

beste Teiler: 44.3 (28.), 74.5 (25.), 231.6 (24.)
 Trefferlage: 0.90 mm rechts, 1.35 mm hoch
 Streuwert: 3.24, horizontal: 3.86, vertikal: 2.48

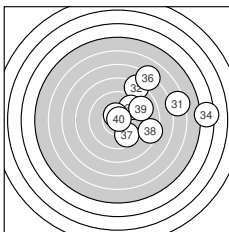

Serie 4: 84.2 (80)

6.4 →	8.2 ↗	9.6 ↗	4.4 →	10.6* ↖
7.1 ↗	9.7 ↘	8.4 →	9.0 →	10.8* ↗

beste Teiler: 30.6 (40.), 99.1 (35.), 318.2 (37.)
 Trefferlage: 5.07 mm rechts, 1.87 mm hoch
 Streuwert: 4.30, horizontal: 5.15, vertikal: 3.23



Ergebnis: **395.9** (376)
 Serien: 98.7 98.9 99.8 98.5
 Zähler: 20 16 4 0 0 0 0 0 0 0
 Innenezehner: 16
 Weitester: 624 (40.), 603 (6.), 569 (11.)
 beste Teiler: 10.4 (8.), 20.0 (12.), 58.0 (10.)
 Trefferlage: 0.42 mm links, 0.31 mm hoch
 Streuwert: 2.19, horizontal: 2.79, vertikal: 1.35

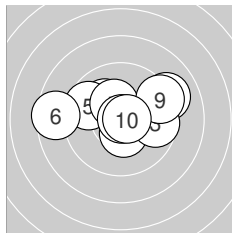
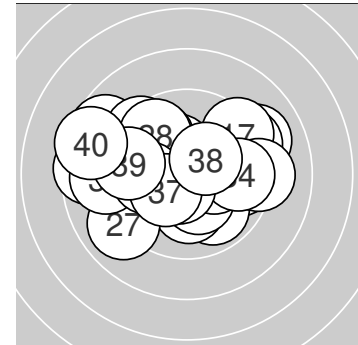

Serie 1: 98.7 (94)

10.4* ↓ 9.1 ↗ 9.7 →
 8.5 ← 10.3* ↖ 10.9* ↗
 beste Teiler: 10.4 (8.), 58.0 (10.), 131.0 (1.)
 Trefferlage: 0.10 mm rechts, 0.69 mm hoch
 Streuwert: 2.36, horizontal: 3.16, vertikal: 1.10

10.1 ↖ 9.7 ↖
 9.3 ↗ 10.7* →

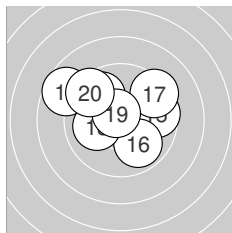

Serie 2: 98.9 (93)

8.7 ↖ 10.9* ← 9.8 ↖
 9.9 ↘ 9.4 ↗ 10.1 ←
 beste Teiler: 20.0 (12.), 76.0 (19.), 120.0 (14.)
 Trefferlage: 0.32 mm links, 0.84 mm hoch
 Streuwert: 2.22, horizontal: 2.69, vertikal: 1.61

10.5* → 9.6 →
 10.6* ↖ 9.4 ↖

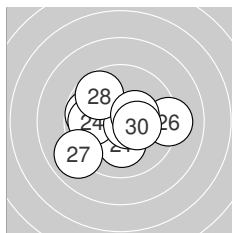

Serie 3: 99.8 (95)

10.1 ↓ 10.7* → 9.8 ←
 9.2 → 9.0 ↗ 9.7 ↖
 beste Teiler: 72.3 (22.), 73.8 (25.), 144.5 (29.)
 Trefferlage: 0.26 mm links, 0.23 mm tief
 Streuwert: 2.09, horizontal: 2.55, vertikal: 1.48

9.9 ← 10.7* ↘
 10.4* → 10.3* →

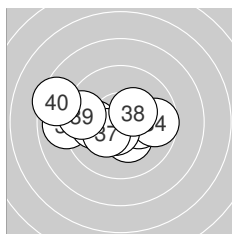

Serie 4: 98.5 (94)

8.9 ← 10.3* ↓ 10.3* →
 10.0 ← 10.3* ↗ 10.4* ↗
 beste Teiler: 95.3 (35.), 149.9 (38.), 164.1 (32.)
 Trefferlage: 1.20 mm links, 0.04 mm tief
 Streuwert: 2.24, horizontal: 3.01, vertikal: 1.00

9.7 → 10.6* ↗
 9.5 ← 8.5 ↖

