

Ergebnis: **415.3** (393)
 Serien: 103.6 104.5 103.4 103.8
 Zähler: 33 7 0 0 0 0 0 0 0 0
 Innenzehner: 30
 Weitestе: 341 (4.), 316 (5.), 300 (13.)
 beste Teiler: 10.0 (34.), 15.1 (7.), 21.6 (12.)
 Trefferlage: 0.06 mm links, 0.01 mm hoch
 Streuwert: 1.21, horizontal: 1.39, vertikal: 1.00

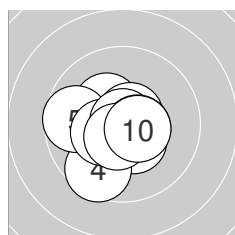
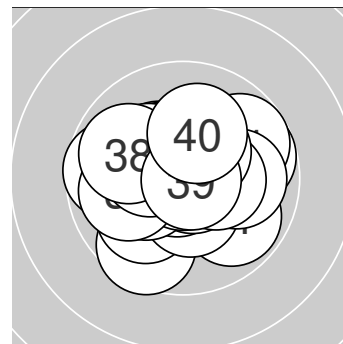

Serie 1: 103.6 (98)

10.3* ↘	10.4* ↘	10.7* ↗	9.6 ↙	9.7 ←
10.4* ←	10.9* ↑	10.5* →	10.6* ↙	10.5* →

beste Teiler: 15.1 (7.), 75.0 (3.), 91.7 (9.)
 Trefferlage: 0.42 mm links, 0.37 mm tief
 Streuwert: 1.26, horizontal: 1.36, vertikal: 1.14

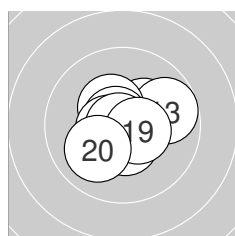

Serie 2: 104.5 (99)

10.3* ↗	10.9* ↙	9.8 →	10.4* ↘	10.5* ↓
10.7* ↘	10.6* ←	10.8* ←	10.5* →	10.0 ↙

beste Teiler: 21.6 (12.), 27.8 (18.), 59.0 (16.)
 Trefferlage: 0.12 mm rechts, 0.01 mm tief
 Streuwert: 1.13, horizontal: 1.32, vertikal: 0.91

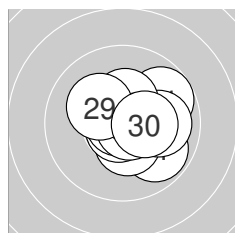

Serie 3: 103.4 (98)

9.8 ↘	10.4* ↓	10.8* ↙	9.8 ↗	10.8* ←
10.0 →	10.8* ↘	10.4* ↑	10.2* ↘	10.4* →

beste Teiler: 27.1 (25.), 46.8 (23.), 50.1 (27.)
 Trefferlage: 0.75 mm rechts, 0.03 mm hoch
 Streuwert: 1.23, horizontal: 1.36, vertikal: 1.08

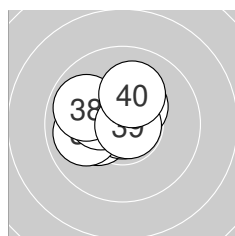

Serie 4: 103.8 (98)

10.7* ↑	10.5* ←	10.3* ←	10.9* ↓	9.9 ←
10.3* ←	10.4* ↗	9.9 ↘	10.8* →	10.1 ↑

beste Teiler: 10.0 (34.), 37.8 (39.), 69.3 (31.)
 Trefferlage: 0.69 mm links, 0.41 mm hoch
 Streuwert: 1.07, horizontal: 1.27, vertikal: 0.83



Ergebnis: **407.4** (387)
 Serien: 102.5 101.3 100.3 103.3
 Zähler: 27 13 0 0 0 0 0 0 0 0
 Innenezehner: 20
 Weitestе: 491 (27.), 368 (2.), 368 (15.)
 beste Teiler: 31.6 (4.), 37.0 (34.), 50.4 (40.)
 Trefferlage: 0.07 mm links, 0.10 mm hoch
 Streuwert: 1.59, horizontal: 1.84, vertikal: 1.28

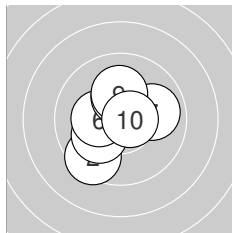
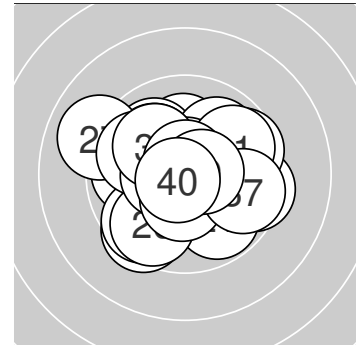

Serie 1: 102.5 (98)

10.3* ←	9.5 ↙	10.6* ↑	10.8* ↗	10.1 ↘
10.3* ←	9.9 →	10.2* ↑	10.1 ↑	10.7* →

beste Teiler: 31.6 (4.), 75.0 (10.), 87.0 (3.)
 Trefferlage: 0.39 mm links, 0.11 mm hoch
 Streuwert: 1.43, horizontal: 1.42, vertikal: 1.44

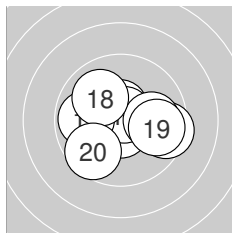

Serie 2: 101.3 (96)

10.6* ↓	10.6* ↖	10.6* ↑	10.7* ↗	9.5 →
10.0 →	9.9 ←	10.0 ↘	9.8 →	9.6 ↘

beste Teiler: 51.8 (14.), 76.0 (11.), 87.2 (12.)
 Trefferlage: 0.18 mm rechts, 0.09 mm tief
 Streuwert: 1.74, horizontal: 2.17, vertikal: 1.16

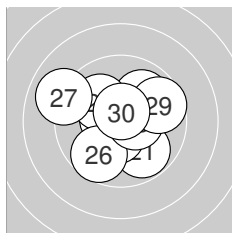

Serie 3: 100.3 (96)

9.8 ↘	10.5* ←	10.0 ↗	10.5* ↓	10.1 ↖
9.7 ↙	9.0 ↖	10.5* →	9.6 →	10.6* ↑

beste Teiler: 77.3 (30.), 103.2 (22.), 117.0 (28.)
 Trefferlage: 0.15 mm links, 0.14 mm hoch
 Streuwert: 1.94, horizontal: 2.19, vertikal: 1.66

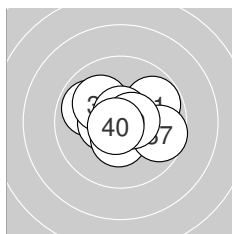

Serie 4: 103.3 (97)

9.8 ↗	9.9 ↖	10.5* ←	10.8* ↑	10.1 ↖
10.4* ↓	9.7 →	10.7* ↑	10.6* →	10.8* ↘

beste Teiler: 37.0 (34.), 50.4 (40.), 62.0 (38.)
 Trefferlage: 0.07 mm rechts, 0.24 mm hoch
 Streuwert: 1.39, horizontal: 1.72, vertikal: 0.94



Ergebnis: **380.0** (364)
 Serien: 95.1 92.6 96.6 95.7
 Zähler: 12 20 8 0 0 0 0 0 0 0
 Innenzehner: 7
 Weitestе: 724 (18.), 678 (8.), 601 (1.)
 beste Teiler: 46.8 (22.), 115.2 (16.), 122.3 (32.)
 Trefferlage: 0.59 mm links, 0.33 mm hoch
 Streuwert: 2.81, horizontal: 3.20, vertikal: 2.36

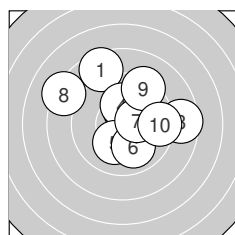
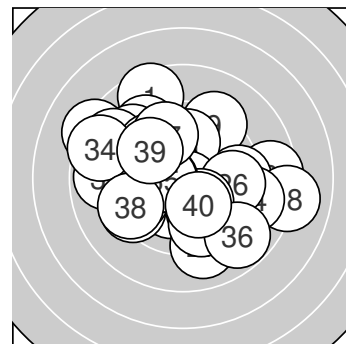

Serie 1: 95.1 (92)

8.5 ↘	10.4* ↑	8.6 →	10.2* ↑	10.1 ↓
10.0 ↓	10.4* →	8.2 ↖	9.3 ↑	9.4 →

beste Teiler: 147.6 (2.), 149.6 (7.), 198.0 (4.)
 Trefferlage: 0.55 mm rechts, 1.23 mm hoch
 Streuwert: 2.89, horizontal: 3.28, vertikal: 2.45

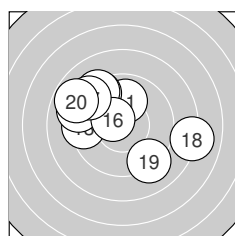

Serie 2: 92.6 (90)

10.0 ↑	9.3 ↘	9.4 ←	9.0 ↖	9.2 ↘
10.5* ↖	9.2 ↖	8.1 →	9.1 ↓	8.8 ↖

beste Teiler: 115.2 (16.), 248.6 (11.), 399.3 (13.)
 Trefferlage: 1.24 mm links, 1.13 mm hoch
 Streuwert: 3.11, horizontal: 3.74, vertikal: 2.30

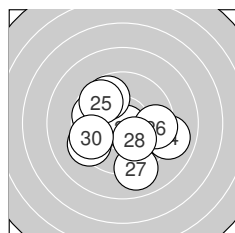

Serie 3: 96.6 (92)

9.7 ↖	10.8* ↓	9.8 ↘	9.0 →	9.7 ↘
9.6 →	9.0 ↓	10.1 ↓	9.3 ↖	9.6 ↖

beste Teiler: 46.8 (22.), 201.4 (28.), 298.9 (23.)
 Trefferlage: 0.24 mm links, 0.64 mm tief
 Streuwert: 2.52, horizontal: 2.86, vertikal: 2.12

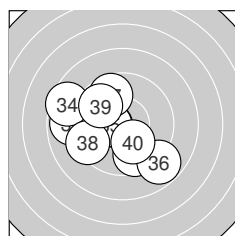

Serie 4: 95.7 (90)

8.9 ←	10.5* ←	9.6 ↓	8.6 ↖	10.4* ←
8.8 ↓	9.7 ↑	9.3 ↖	9.8 ↖	10.1 ↓

beste Teiler: 122.3 (32.), 130.1 (35.), 210.1 (40.)
 Trefferlage: 1.43 mm links, 0.38 mm tief
 Streuwert: 2.62, horizontal: 2.93, vertikal: 2.28



ISSF AR 40

StandNr: 5

HÖLLER, Lena #7826

Frauen

Competition

StartNr: 335

12.10.2024 13:14

SV 1582 Oberzeiring

Ergebnis: **0.0** (0)_{DNS}
Serien:
Zähler: 0 0 0 0 0 0 0 0 0 0 0
Innenzehner: 0
Weiteste:
~~beste Teiler~~
Trefferlage: 0.00 mm , 0.00 mm
Streuwert:

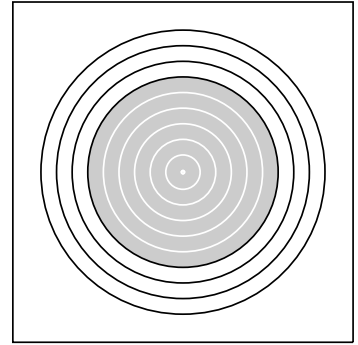

Ergebnis: **391.8** (374)
 Serien: 96.5 98.0 95.2 102.1
 Zähler: 18 18 4 0 0 0 0 0 0 0
 Innenzehner: 15
 Weitester: 726 (28.), 687 (39.), 589 (23.)
 beste Teiler: 27.5 (37.), 38.6 (32.), 46.0 (12.)
 Trefferlage: 0.40 mm rechts, 1.05 mm hoch
 Streuwert: 2.29, horizontal: 2.53, vertikal: 2.01

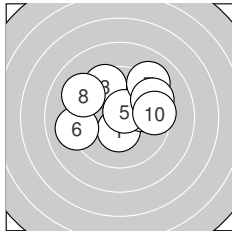
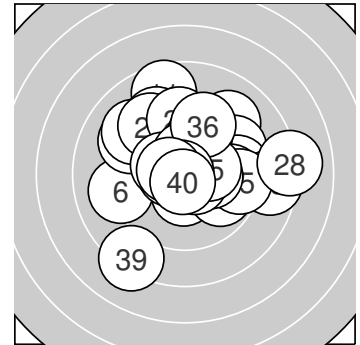

Serie 1: 96.5 (93)

10.4* ↓	9.7 →	9.5 ↘	10.0 →	10.6* ↗
9.1 ←	9.1 ↗	9.2 ↘	9.4 ↗	9.5 →

beste Teiler: 79.5 (5.), 133.3 (1.), 244.1 (4.)
 Trefferlage: 0.60 mm rechts, 1.09 mm hoch
 Streuwert: 2.41, horizontal: 2.98, vertikal: 1.64

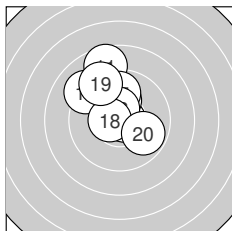

Serie 2: 98.0 (93)

8.6 ↑	10.8* →	9.5 ↘	10.1 ↑	9.8 ↑
10.5* ↑	9.1 ↘	10.5* ←	9.3 ↘	9.8 ↘

beste Teiler: 46.0 (12.), 102.0 (18.), 120.3 (16.)
 Trefferlage: 0.73 mm links, 2.00 mm hoch
 Streuwert: 1.87, horizontal: 1.65, vertikal: 2.07

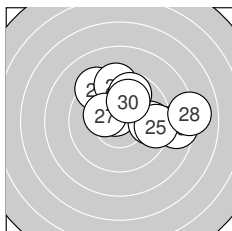

Serie 3: 95.2 (91)

10.6* ↘	9.3 ↘	8.6 →	9.7 →	9.4 →
9.4 ↑	10.3* ↘	8.0 →	9.8 ↑	10.1 ↑

beste Teiler: 82.3 (21.), 164.0 (27.), 225.8 (30.)
 Trefferlage: 1.72 mm rechts, 1.27 mm hoch
 Streuwert: 2.52, horizontal: 3.18, vertikal: 1.60

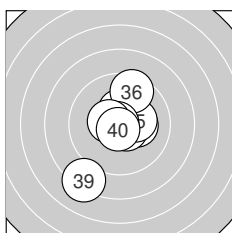

Serie 4: 102.1 (97)

10.3* →	10.8* →	10.4* ↑	10.6* ↘	10.3* →
9.5 ↑	10.8* ↘	10.5* ↘	8.2 ↘	10.7* ↓

beste Teiler: 27.5 (37.), 38.6 (32.), 55.3 (40.)
 Trefferlage: 0.05 mm rechts, 0.14 mm tief
 Streuwert: 1.98, horizontal: 1.59, vertikal: 2.30



Ergebnis: **417.2** (395)
 Serien: 104.8 103.4 105.4 103.6
 Zähler: 35 5 0 0 0 0 0 0 0 0
 Innenzehner: 29
 Weitestе: 398 (25.), 379 (6.), 299 (16.)
 beste Teiler: 3.1 (23.), 11.0 (8.), 13.0 (15.)
 Trefferlage: 0.14 mm rechts, 0.17 mm hoch
 Streuwert: 1.18, horizontal: 1.26, vertikal: 1.09

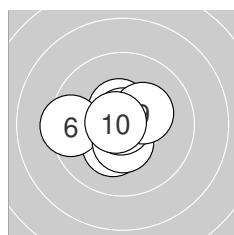
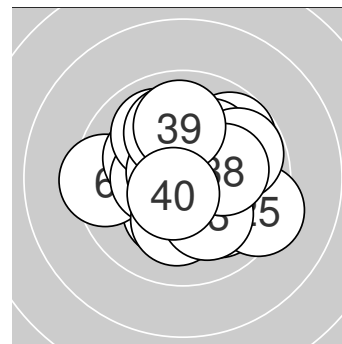

Serie 1: 104.8 (99)

10.7* ↓	10.5* ↑	10.8* ↑	10.8* ←	10.3* ↓
9.4 ←	10.4* ↓	10.9* ←	10.3* ↗	10.7* ←

beste Teiler: 11.0 (8.), 41.1 (3.), 50.0 (4.)
 Trefferlage: 0.44 mm links, 0.11 mm tief
 Streuwert: 1.11, horizontal: 1.32, vertikal: 0.84

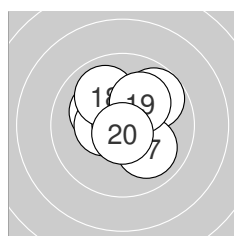

Serie 2: 103.4 (99)

10.8* ←	10.5* ↑	10.2* ↘	10.4* ←	10.9* ↑
9.8 ↗	10.0 ↘	10.0 ↘	10.1 ↗	10.7* ↓

beste Teiler: 13.0 (15.), 27.0 (11.), 60.0 (20.)
 Trefferlage: 0.07 mm rechts, 0.58 mm hoch
 Streuwert: 1.27, horizontal: 1.33, vertikal: 1.21

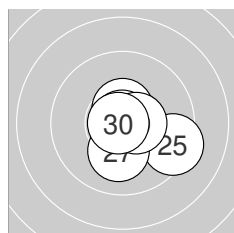

Serie 3: 105.4 (99)

10.8* ↗	10.6* →	10.9* ↑	10.8* ↓	9.4 ↘
10.5* ↑	10.1 ↓	10.9* ↑	10.6* →	10.8* ←

beste Teiler: 3.1 (23.), 17.4 (28.), 32.0 (30.)
 Trefferlage: 0.51 mm rechts, 0.24 mm tief
 Streuwert: 1.06, horizontal: 1.20, vertikal: 0.90

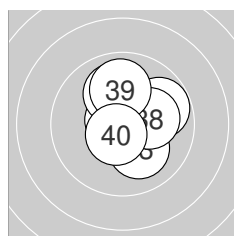

Serie 4: 103.6 (98)

10.8* ↘	10.8* →	10.1 ↘	10.7* ↗	9.8 ↗
10.7* ↘	10.0 ↑	10.2* →	9.9 ↑	10.6* ↓

beste Teiler: 27.2 (32.), 35.8 (31.), 59.5 (36.)
 Trefferlage: 0.44 mm rechts, 0.47 mm hoch
 Streuwert: 1.20, horizontal: 1.14, vertikal: 1.27



Ergebnis: **405.9** (389)
 Serien: 100.3 100.5 102.3 102.8
 Zähler: 29 11 0 0 0 0 0 0 0 0
 Innenzehner: 20
 Weitester: 416 (19.), 387 (5.), 384 (2.)
 beste Teiler: 8.9 (27.), 38.2 (26.), 53.9 (37.)
 Trefferlage: 0.26 mm links, 0.14 mm tief
 Streuwert: 1.59, horizontal: 1.65, vertikal: 1.52

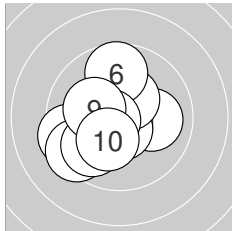
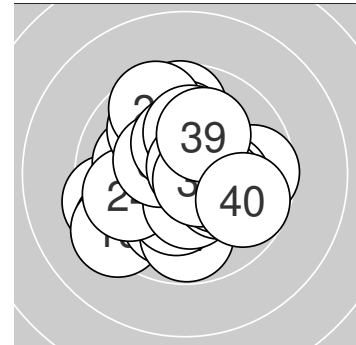

Serie 1: 100.3 (96)

10.0 →	9.4 ←	10.6* ↓	10.4* ↗	9.4 ↙
9.7 ↑	9.8 ↘	10.6* ←	10.2* ↖	10.2* ↘

beste Teiler: 77.4 (8.), 84.8 (3.), 144.0 (4.)
 Trefferlage: 0.92 mm links, 0.34 mm tief
 Streuwert: 1.72, horizontal: 1.76, vertikal: 1.68

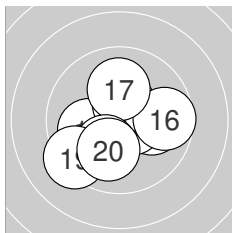

Serie 2: 100.5 (98)

10.1 ←	10.0 →	10.0 ←	10.5* ↑	10.6* →
9.7 →	10.1 ↑	10.1 ↘	9.3 ↙	10.1 ↘

beste Teiler: 92.1 (15.), 117.8 (14.), 211.6 (18.)
 Trefferlage: 0.25 mm links, 0.54 mm tief
 Streuwert: 1.77, horizontal: 2.01, vertikal: 1.49

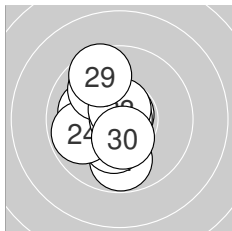

Serie 3: 102.3 (96)

9.8 ↓	10.3* ↓	10.1 ←	9.8 ←	9.9 ↖
10.8* ↗	10.9* ↗	10.7* ↑	9.6 ↖	10.4* ↓

beste Teiler: 8.9 (27.), 38.2 (26.), 71.0 (28.)
 Trefferlage: 0.74 mm links, 0.00 mm
 Streuwert: 1.48, horizontal: 1.08, vertikal: 1.79

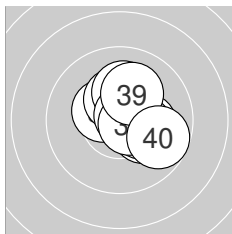

Serie 4: 102.8 (99)

10.2* ↘	10.4* ↖	10.3* ↑	10.2* →	10.3* →
10.2* ↑	10.7* ↗	10.7* →	10.1 ↑	9.7 →

beste Teiler: 53.9 (37.), 75.6 (38.), 135.6 (32.)
 Trefferlage: 0.86 mm rechts, 0.31 mm hoch
 Streuwert: 1.15, horizontal: 1.15, vertikal: 1.15



ISSF AR 40

StandNr: 9

WURZWALLNER, Peter #760

Männer

Competition

StartNr: 204

12.10.2024 13:14

SV RAIKA Langenwang

Ergebnis: **0.0** (0)_{DNS}
Serien:
Zähler: 0 0 0 0 0 0 0 0 0 0 0
Innenzehner: 0
Weiteste:
~~beste Teiler~~
Trefferlage: 0.00 mm , 0.00 mm
Streuwert:

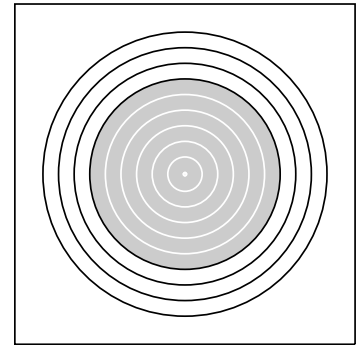

Ergebnis: **406.7** (390)
 Serien: 101.8 102.6 101.2 101.1
 Zähler: 31 8 1 0 0 0 0 0 0 0
 Innenzehner: 25
 Weitesten: 508 (32.), 491 (2.), 442 (22.)
 beste Teiler: 26.4 (38.), 35.3 (20.), 40.8 (35.)
 Trefferlage: 0.42 mm rechts, 0.19 mm tief
 Streuwert: 1.65, horizontal: 1.90, vertikal: 1.35

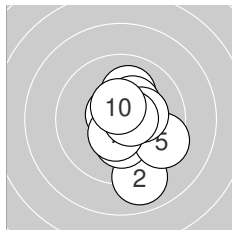
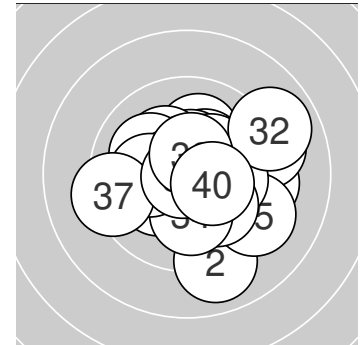

Serie 1: 101.8 (98)

10.1 ↗	9.0 ↓	10.3* ↓	10.3* ↗	9.5 ↘
10.7* ↖	10.5* ↙	10.3* →	10.6* →	10.5* ↑

beste Teiler: 71.0 (6.), 81.3 (9.), 104.7 (10.)
 Trefferlage: 0.77 mm rechts, 0.40 mm tief
 Streuwert: 1.62, horizontal: 1.18, vertikal: 1.96

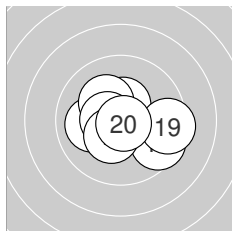

Serie 2: 102.6 (98)

10.7* ↘	10.5* ←	9.6 ↘	10.5* ↑	10.0 ←
10.2* ↖	10.5* ←	10.4* ↙	9.4 →	10.8* ↘

beste Teiler: 35.3 (20.), 64.6 (11.), 106.1 (12.)
 Trefferlage: 0.15 mm rechts, 0.17 mm tief
 Streuwert: 1.52, horizontal: 1.92, vertikal: 0.97

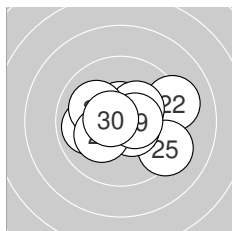

Serie 3: 101.2 (97)

10.6* ↑	9.2 →	10.3* ↗	9.9 ←	9.3 ↘
10.5* ↘	10.1 ↖	10.2* ↙	10.5* →	10.6* ←

beste Teiler: 82.2 (30.), 95.1 (21.), 109.0 (26.)
 Trefferlage: 0.42 mm rechts, 0.03 mm hoch
 Streuwert: 1.78, horizontal: 2.26, vertikal: 1.13

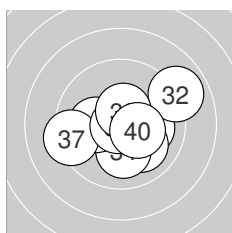

Serie 4: 101.1 (97)

10.1 →	8.9 ↗	10.0 ↘	10.1 ↓	10.8* ↖
10.2* ←	9.3 ←	10.8* ↙	10.5* ↑	10.4* ↘

beste Teiler: 26.4 (38.), 40.8 (35.), 108.2 (39.)
 Trefferlage: 0.34 mm rechts, 0.22 mm tief
 Streuwert: 1.88, horizontal: 2.31, vertikal: 1.31



Ergebnis: **388.5** (370)
 Serien: 98.8 95.7 96.7 97.3
 Zähler: 14 23 2 1 0 0 0 0 0 0
 Innenezehner: 11
 Weitester: 799 (16.), 684 (18.), 609 (24.)
 beste Teiler: 22.8 (22.), 47.0 (17.), 82.8 (10.)
 Trefferlage: 0.52 mm links, 0.42 mm tief
 Streuwert: 2.48, horizontal: 2.89, vertikal: 1.98

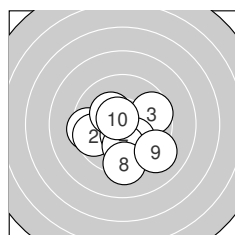
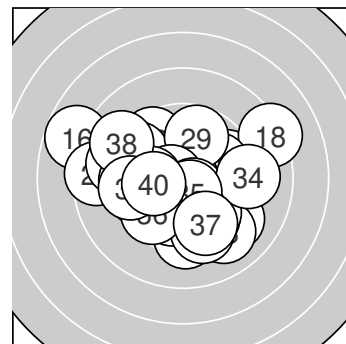

Serie 1: 98.8 (95)

9.5 ← 9.7 ← 9.6 →
 10.3* ↘ 10.0 ↓ 9.3 ↓
 beste Teiler: 82.8 (10.), 111.7 (4.), 169.1 (6.)
 Trefferlage: 0.06 mm links, 1.06 mm tief
 Streuwert: 2.04, horizontal: 2.30, vertikal: 1.74

10.5* ↓ 10.2* ↘
 9.1 ↘ 10.6* ↘

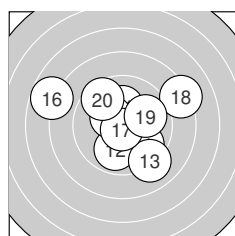

Serie 2: 95.7 (90)

9.8 ↘ 9.9 ↓ 9.1 ↘
 7.8 ← 10.8* ↓ 8.2 →
 beste Teiler: 47.0 (17.), 147.2 (15.), 194.0 (14.)
 Trefferlage: 0.18 mm rechts, 0.36 mm hoch
 Streuwert: 3.09, horizontal: 3.63, vertikal: 2.44

10.2* ↑ 10.4* ↘
 9.9 → 9.6 ↘

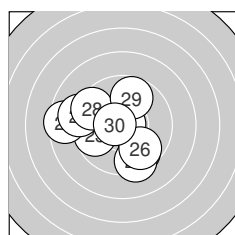

Serie 3: 96.7 (91)

9.6 ↘ 10.9* → 9.7 ←
 9.7 ↘ 9.1 ← 9.5 ↘
 beste Teiler: 22.8 (22.), 83.4 (30.), 303.2 (29.)
 Trefferlage: 1.14 mm links, 0.38 mm tief
 Streuwert: 2.51, horizontal: 2.86, vertikal: 2.11

8.5 ← 9.4 ↓
 9.7 ↑ 10.6* ←

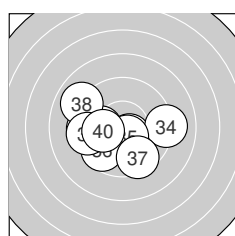

Serie 4: 97.3 (94)

9.5 ← 10.5* ↘ 10.0 ←
 9.7 ↗ 9.5 ↘ 9.0 ↘
 beste Teiler: 109.5 (35.), 109.9 (32.), 209.6 (40.)
 Trefferlage: 1.08 mm links, 0.60 mm tief
 Streuwert: 2.28, horizontal: 2.84, vertikal: 1.52

9.1 → 10.5* ↘
 9.4 ← 10.1 ←



Ergebnis: **393.0** (375)
 Serien: 96.4 97.8 98.7 100.1
 Zähler: 18 19 3 0 0 0 0 0 0 0
 Innenzehner: 12
 Weitester: 527 (29.), 525 (24.), 507 (6.)
 beste Teiler: 33.7 (39.), 51.7 (12.), 72.7 (27.)
 Trefferlage: 0.28 mm links, 0.58 mm hoch
 Streuwert: 2.21, horizontal: 2.62, vertikal: 1.71

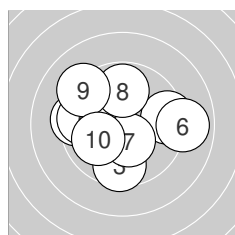
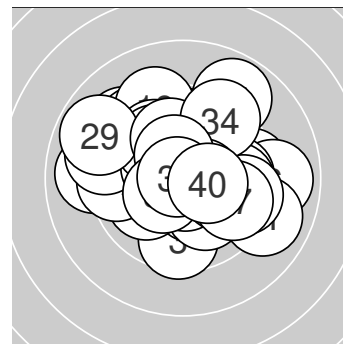

Serie 1: 96.4 (92)

9.4 →	10.1 ↘	9.6 ↓	9.4 ←	9.6 ←
8.9 →	10.4* ↓	9.8 ↑	9.2 ↘	10.0 ↗

beste Teiler: 144.6 (7.), 213.4 (2.), 239.9 (10.)
 Trefferlage: 0.50 mm links, 0.24 mm hoch
 Streuwert: 2.52, horizontal: 3.00, vertikal: 1.93

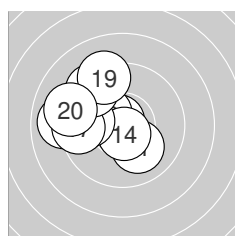

Serie 2: 97.8 (94)

10.1 ↓	10.7* ↘	10.3* ↘	10.7* ↓	9.0 ←
9.8 ←	9.5 ←	9.4 ↘	9.2 ↘	9.1 ←

beste Teiler: 51.7 (12.), 74.1 (14.), 175.5 (13.)
 Trefferlage: 2.06 mm links, 0.75 mm hoch
 Streuwert: 1.87, horizontal: 2.02, vertikal: 1.70

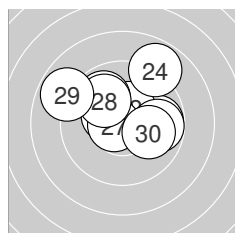

Serie 3: 98.7 (93)

9.8 →	10.4* ↑	9.9 ↘	8.9 ↗	9.8 →
10.4* ↘	10.7* ←	10.0 ↘	8.8 ↘	10.0 →

beste Teiler: 72.7 (27.), 137.6 (22.), 140.4 (26.)
 Trefferlage: 0.15 mm rechts, 1.18 mm hoch
 Streuwert: 2.13, horizontal: 2.55, vertikal: 1.59

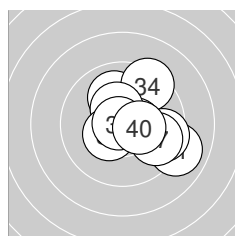

Serie 4: 100.1 (96)

9.0 →	9.5 →	10.0 ↑	9.4 ↗	10.5* →
10.4* ↘	9.7 →	10.4* ↗	10.8* ←	10.4* →

beste Teiler: 33.7 (39.), 105.0 (35.), 138.9 (36.)
 Trefferlage: 1.25 mm rechts, 0.14 mm hoch
 Streuwert: 1.80, horizontal: 1.92, vertikal: 1.68



Ergebnis: **401.8** (384)
 Serien: 97.7 101.9 100.7 101.5
 Zähler: 27 10 3 0 0 0 0 0 0 0
 Innenezehner: 20
 Weitestе: 652 (8.), 581 (7.), 509 (28.)
 beste Teiler: 31.9 (15.), 53.7 (9.), 72.4 (32.)
 Trefferlage: 0.18 mm links, 0.12 mm tief
 Streuwert: 1.89, horizontal: 2.40, vertikal: 1.19

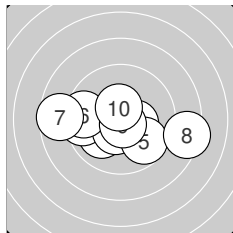
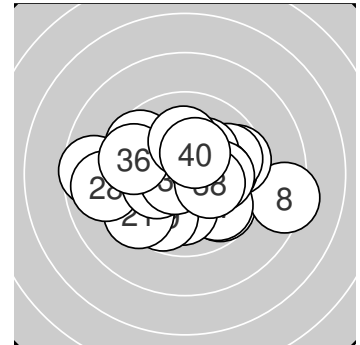

Serie 1: 97.7 (93)

10.0 ↙	9.5 ←	10.4* →	10.5* ↓	9.7 ↘
9.5 ←	8.6 ←	8.3 →	10.7* ↓	10.5* ↑

beste Teiler: 53.7 (9.), 114.2 (10.), 122.0 (4.)
 Trefferlage: 0.51 mm links, 0.55 mm tief
 Streuwert: 2.54, horizontal: 3.46, vertikal: 0.99

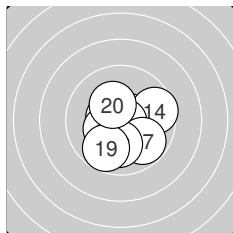

Serie 2: 101.9 (97)

10.5* ←	10.2* ↘	10.6* →	9.6 →	10.8* ↘
10.3* ↙	9.8 ↘	10.0 ↓	9.8 ↙	10.3* ↖

beste Teiler: 31.9 (15.), 78.7 (13.), 112.5 (11.)
 Trefferlage: 0.33 mm rechts, 0.58 mm tief
 Streuwert: 1.50, horizontal: 1.60, vertikal: 1.39

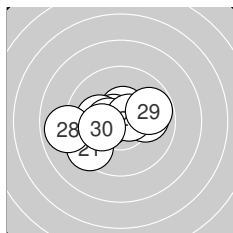

Serie 3: 100.7 (96)

9.4 ↙	10.0 →	10.5* ↑	10.7* ↖	10.1 ←
10.5* ←	10.6* →	8.9 ←	9.8 →	10.2* ←

beste Teiler: 74.2 (24.), 88.7 (27.), 110.2 (23.)
 Trefferlage: 0.74 mm links, 0.06 mm tief
 Streuwert: 1.84, horizontal: 2.38, vertikal: 1.03

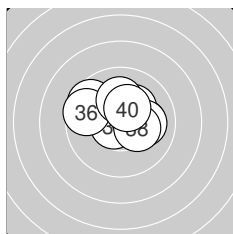

Serie 4: 101.5 (98)

9.6 ↘	10.7* ↙	10.1 →	10.4* ↗	10.2* ↗
9.6 ←	10.1 →	10.3* ↘	10.1 ↑	10.4* ↑

beste Teiler: 72.4 (32.), 137.8 (34.), 149.4 (40.)
 Trefferlage: 0.20 mm rechts, 0.71 mm hoch
 Streuwert: 1.52, horizontal: 1.94, vertikal: 0.94



Ergebnis: **413.6** (393)
 Serien: 103.6 103.9 101.9 104.2
 Zähler: 33 7 0 0 0 0 0 0 0 0
 Innenzehner: 27
 Weitester: 351 (10.), 350 (14.), 324 (37.)
 beste Teiler: 6.7 (34.), 14.0 (17.), 23.3 (35.)
 Trefferlage: 0.56 mm rechts, 0.31 mm hoch
 Streuwert: 1.20, horizontal: 1.22, vertikal: 1.17

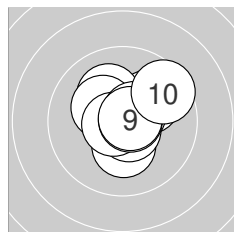
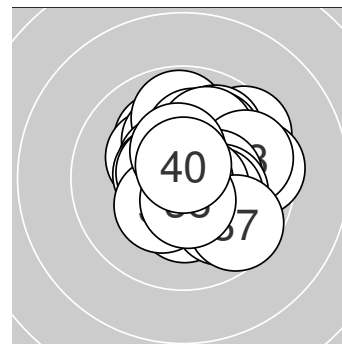

Serie 1: 103.6 (99)

10.0 ↗	10.3* ↓	10.1 ↘	10.3* ↖	10.7* ↘
10.7* ←	10.6* ↗	10.7* →	10.7* →	9.5 ↗

beste Teiler: 55.5 (8.), 57.2 (9.), 66.4 (6.)
 Trefferlage: 0.41 mm rechts, 0.44 mm hoch
 Streuwert: 1.21, horizontal: 1.27, vertikal: 1.15

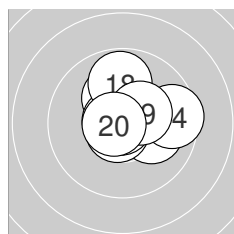

Serie 2: 103.9 (98)

10.8* ↘	10.1 →	10.2* ↑	9.6 →	10.7* ←
10.7* ↗	10.9* ←	9.8 ↑	10.4* ↗	10.7* ←

beste Teiler: 14.0 (17.), 43.9 (11.), 60.4 (20.)
 Trefferlage: 0.46 mm rechts, 0.45 mm hoch
 Streuwert: 1.23, horizontal: 1.38, vertikal: 1.07

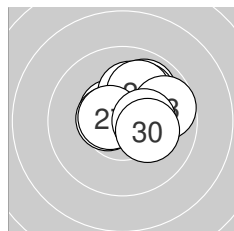

Serie 3: 101.9 (98)

10.5* ↖	9.9 ↗	10.0 ↗	10.1 ↑	10.5* ←
10.0 ↗	10.6* ←	9.7 →	10.4* →	10.2* ↘

beste Teiler: 92.7 (27.), 105.3 (25.), 105.6 (21.)
 Trefferlage: 0.80 mm rechts, 0.94 mm hoch
 Streuwert: 1.17, horizontal: 1.33, vertikal: 1.00

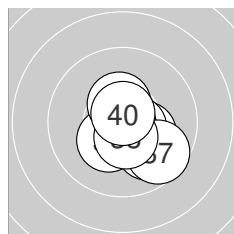

Serie 4: 104.2 (98)

9.9 ↘	10.3* ↘	10.6* ↘	10.9* ↖	10.9* ↘
10.3* ↗	9.7 ↘	10.5* ↓	10.4* ↑	10.7* ↑

beste Teiler: 6.7 (34.), 23.3 (35.), 61.0 (40.)
 Trefferlage: 0.57 mm rechts, 0.57 mm tief
 Streuwert: 1.06, horizontal: 1.06, vertikal: 1.05



Ergebnis: **394.2** (374)
 Serien: 95.2 98.7 102.3 98.0
 Zähler: 20 15 4 1 0 0 0 0 0 0
 Innenzehner: 16
 Weitester: 833 (5.), 704 (16.), 667 (3.)
 beste Teiler: 35.0 (30.), 37.9 (40.), 48.1 (28.)
 Trefferlage: 1.13 mm rechts, 0.44 mm tief
 Streuwert: 2.18, horizontal: 2.51, vertikal: 1.80

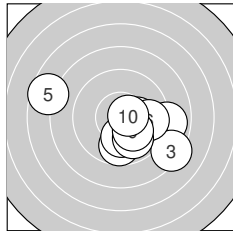
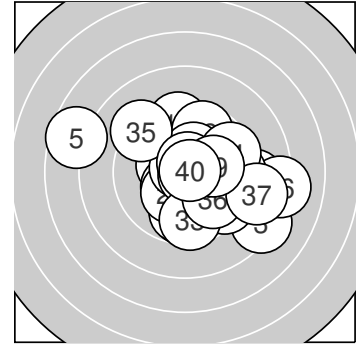

Serie 1: 95.2 (90)

8.9 →	9.7 ↓	8.3 ↘	10.2* →	7.6 ←
9.7 →	10.1 ↓	9.9 ↘	10.2* ↘	10.6* →

beste Teiler: 84.7 (10.), 184.0 (4.), 198.8 (9.)
 Trefferlage: 1.10 mm rechts, 1.08 mm tief
 Streuwert: 2.93, horizontal: 3.72, vertikal: 1.83

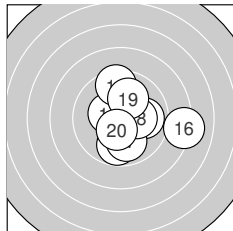

Serie 2: 98.7 (94)

10.4* ←	10.5* ↘	9.8 ↓	9.5 ↑	9.9 →
8.1 →	9.9 ↓	10.2* →	10.0 ↑	10.4* ↓

beste Teiler: 119.4 (12.), 133.7 (20.), 142.8 (11.)
 Trefferlage: 1.10 mm rechts, 0.21 mm tief
 Streuwert: 2.18, horizontal: 2.36, vertikal: 1.98

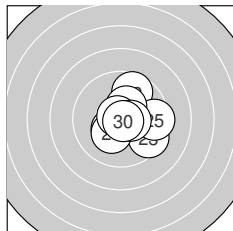

Serie 3: 102.3 (97)

10.6* ↗	9.7 ↑	9.5 ↘	10.4* ↙	9.5 →
10.3* ↑	10.2* ↙	10.8* ↖	10.5* →	10.8* ↘

beste Teiler: 35.0 (30.), 48.1 (28.), 84.8 (21.)
 Trefferlage: 0.83 mm rechts, 0.02 mm hoch
 Streuwert: 1.50, horizontal: 1.56, vertikal: 1.44

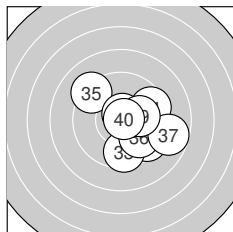

Serie 4: 98.0 (93)

10.0 ↘	9.5 ↘	9.6 ↓	9.5 →	9.2 ↖
9.8 ↘	8.8 →	10.7* ↑	10.1 →	10.8* →

beste Teiler: 37.9 (40.), 71.5 (38.), 212.6 (39.)
 Trefferlage: 1.49 mm rechts, 0.51 mm tief
 Streuwert: 2.12, horizontal: 2.27, vertikal: 1.97



Ergebnis: **424.3** (399)
 Serien: 105.4 106.2 106.3 106.4
 Zähler: 39 1 0 0 0 0 0 0 0 0
 Innenzehner: 39
 Weitester: 272 (9.), 147 (21.), 145 (2.)
 beste Teiler: 18.4 (37.), 26.9 (22.), 33.1 (23.)
 Trefferlage: 0.03 mm links, 0.37 mm tief
 Streuwert: 0.67, horizontal: 0.72, vertikal: 0.61

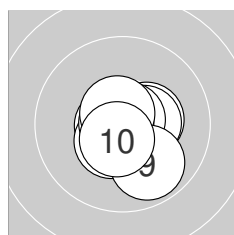
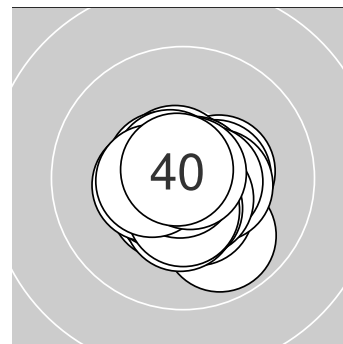

Serie 1: 105.4 (99)

10.7* ←	10.4* →	10.5* ↘	10.4* →	10.6* ↓
10.8* ↗	10.8* ←	10.7* ↘	9.9 ↓	10.6* ↓

beste Teiler: 38.8 (7.), 41.7 (6.), 64.4 (1.)
 Trefferlage: 0.19 mm rechts, 0.37 mm tief
 Streuwert: 0.87, horizontal: 0.87, vertikal: 0.88

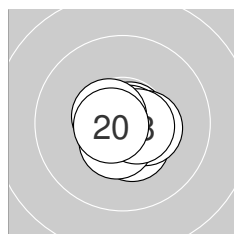

Serie 2: 106.2 (100)

10.8* ↗	10.4* ↓	10.8* →	10.4* →	10.7* ↘
10.7* ↘	10.5* ↓	10.6* →	10.6* ↖	10.7* ←

beste Teiler: 35.1 (13.), 47.4 (11.), 52.6 (16.)
 Trefferlage: 0.18 mm rechts, 0.30 mm tief
 Streuwert: 0.62, horizontal: 0.70, vertikal: 0.52

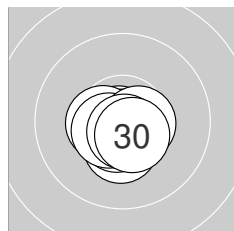

Serie 3: 106.3 (100)

10.4* ↓	10.8* ↙	10.8* ↓	10.6* ↓	10.7* ↓
10.5* ←	10.6* ↙	10.6* →	10.7* ↓	10.6* ↘

beste Teiler: 26.9 (22.), 33.1 (23.), 61.2 (25.)
 Trefferlage: 0.10 mm links, 0.56 mm tief
 Streuwert: 0.52, horizontal: 0.61, vertikal: 0.42

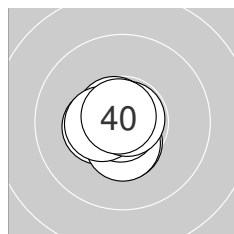

Serie 4: 106.4 (100)

10.6* ←	10.8* ↓	10.5* ↓	10.4* ←	10.7* ↘
10.4* ↓	10.9* ↙	10.5* ←	10.8* ↗	10.8* ↘

beste Teiler: 18.4 (37.), 33.5 (32.), 34.4 (39.)
 Trefferlage: 0.40 mm links, 0.26 mm tief
 Streuwert: 0.58, horizontal: 0.58, vertikal: 0.59



Ergebnis: 380.3 (363)
Serien: 96.8 97.3 98.2 88.0
Zähler: 15 15 8 2 0 0 0 0 0 0
Innenzehner: 13
Weiteste: 903 (2.), 820 (26.), 745 (32.)
beste Teiler: 17.0 (8.), 18.9 (23.), 111.2 (14.)
Trefferlage: 0.01 mm links, 0.79 mm hoch
Streuwert: 3.01, horizontal: 3.29, vertikal: 2.69

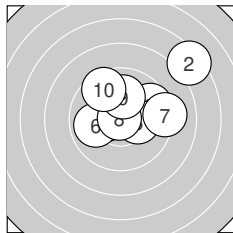
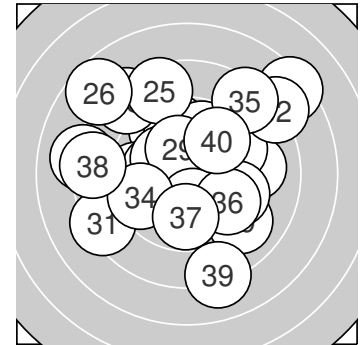

Serie 1: 96.8 (92)

9.9 → 7.3 ↗ 9.6 → 10.3* ← 10.2* →
 9.9 ← 9.1 → 10.9* ↘ 10.0 ↑ 9.6 ↖

beste Teiler: 17.0 (8.), 151.0 (4.), 177.0 (5.)
Trefferlage: 1.30 mm rechts, 1.29 mm hoch
Streuwert: 2.54, horizontal: 3.02, vertikal: 1.94

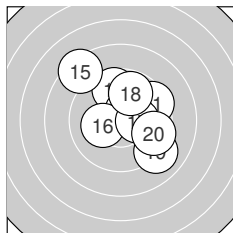

Serie 2: 97.3 (93)

9.5 → 9.7 ↑ 10.4* ↗ 10.5* ↗ 8.4 ↖
 10.2* ← 10.3* → 9.8 ↑ 9.0 ↘ 9.5 →

beste Teiler: 111.2 (14.), 136.5 (13.), 172.1 (17.)
Trefferlage: 0.79 mm rechts, 0.92 mm hoch
Streuwert: 2.41, horizontal: 2.46, vertikal: 2.36

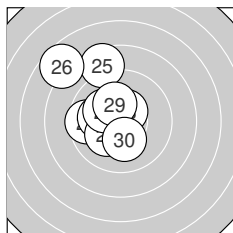

Serie 3: 98.2 (94)

9.6 ← 10.1 ← 10.9* ↖ 10.2* ↖ 8.6 ↑
 7.7 ↘ 10.2* ↘ 10.5* ↗ 10.2* ↖ 10.2* ↓

beste Teiler: 18.9 (23.), 113.1 (28.), 183.7 (29.)
Trefferlage: 1.62 mm links, 1.23 mm hoch
Streuwert: 2.28, horizontal: 1.97, vertikal: 2.56

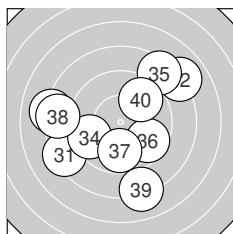

Serie 4: 88.0 (84)

8.3 ↖ 8.0 ↗ 8.1 ← 9.6 ← 8.4 ↗
 9.6 ↘ 9.8 ↓ 8.4 ← 8.1 ↓ 9.7 ↗

beste Teiler: 290.1 (37.), 307.3 (40.), 333.3 (36.)
Trefferlage: 0.55 mm links, 0.30 mm tief
Streuwert: 4.22, horizontal: 4.70, vertikal: 3.68



Ergebnis: **409.1** (388)
 Serien: 104.0 102.3 101.7 101.1
 Zähler: 28 12 0 0 0 0 0 0 0 0
 Innenezehner: 24
 Weitester: 432 (37.), 342 (18.), 341 (36.)
 beste Teiler: 18.0 (6.), 18.2 (40.), 21.2 (1.)
 Trefferlage: 0.08 mm rechts, 0.18 mm hoch
 Streuwert: 1.50, horizontal: 1.68, vertikal: 1.30

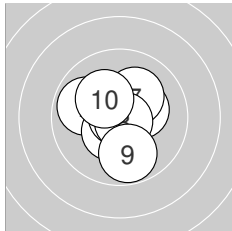
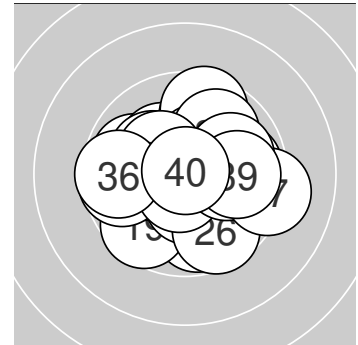

Serie 1: 104.0 (98)

10.9* ↘	9.9 ←	10.6* ↖	10.4* ↙	10.3* →
10.9* ←	10.2* ↗	10.8* ↘	9.8 ↓	10.2* ↖

beste Teiler: 18.0 (6.), 21.2 (1.), 43.1 (8.)
 Trefferlage: 0.11 mm links, 0.09 mm hoch
 Streuwert: 1.25, horizontal: 1.19, vertikal: 1.29

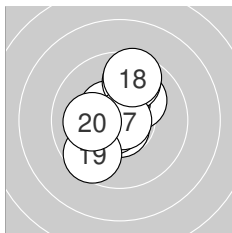

Serie 2: 102.3 (97)

10.7* ↓	10.4* ←	10.7* ↗	10.5* ↖	10.1 ↗
9.7 ↑	10.9* →	9.6 ↑	9.6 ↙	10.1 ←

beste Teiler: 22.0 (17.), 61.2 (11.), 63.6 (13.)
 Trefferlage: 0.34 mm links, 0.44 mm hoch
 Streuwert: 1.53, horizontal: 1.26, vertikal: 1.76

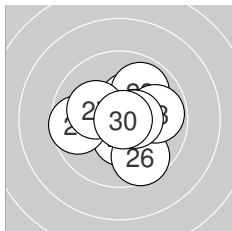

Serie 3: 101.7 (96)

10.3* ↗	10.4* ↓	9.9 ↗	10.5* →	9.7 ←
9.6 ↓	10.2* ↖	9.8 →	10.5* →	10.8* →

beste Teiler: 27.2 (30.), 111.0 (29.), 113.0 (24.)
 Trefferlage: 0.42 mm rechts, 0.00 mm
 Streuwert: 1.58, horizontal: 1.75, vertikal: 1.39

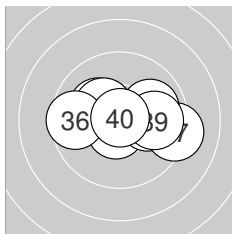

Serie 4: 101.1 (97)

10.6* ↙	10.1 →	10.3* ↖	10.2* ↖	10.3* ↖
9.6 ←	9.2 →	10.0 →	9.9 →	10.9* ↑

beste Teiler: 18.2 (40.), 79.1 (31.), 156.8 (33.)
 Trefferlage: 0.35 mm rechts, 0.22 mm hoch
 Streuwert: 1.76, horizontal: 2.39, vertikal: 0.72



Ergebnis: **380.8** (363)
 Serien: 95.1 93.9 93.6 98.2
 Zähler: 13 19 6 2 0 0 0 0 0 0
 Innenezehner: 7
 Weitester: 936 (22.), 869 (23.), 680 (8.)
 beste Teiler: 50.2 (30.), 86.0 (9.), 120.3 (32.)
 Trefferlage: 1.21 mm links, 0.80 mm tief
 Streuwert: 2.73, horizontal: 3.55, vertikal: 1.51

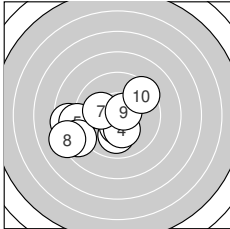
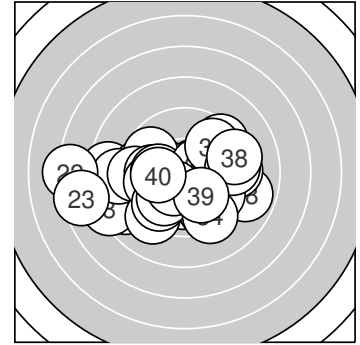

Serie 1: 95.1 (92)

8.5 ←	10.0 ↓	10.4* ↓	10.2* ↓	9.0 ←
8.7 ↙	10.1 ←	8.2 ↘	10.6* ↗	9.4 ↗

beste Teiler: 86.0 (9.), 132.0 (3.), 179.6 (4.)
 Trefferlage: 1.99 mm links, 0.93 mm tief
 Streuwert: 2.60, horizontal: 3.25, vertikal: 1.71

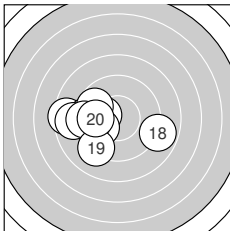

Serie 2: 93.9 (89)

8.4 ←	10.2* ←	9.5 ←	9.7 ↖	10.0 ←
8.8 ←	9.3 ←	8.9 →	9.2 ↗	9.9 ←

beste Teiler: 178.3 (12.), 232.3 (15.), 269.0 (20.)
 Trefferlage: 2.63 mm links, 0.46 mm tief
 Streuwert: 2.36, horizontal: 3.02, vertikal: 1.41

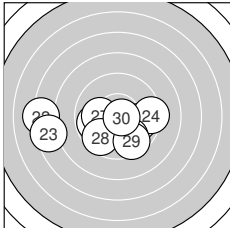

Serie 3: 93.6 (88)

9.9 →	7.2 ←	7.5 ←	9.3 →	9.8 ↘
9.8 ←	10.1 ←	9.6 ↗	9.6 ↘	10.8* →

beste Teiler: 50.2 (30.), 217.0 (27.), 264.6 (21.)
 Trefferlage: 1.45 mm links, 1.16 mm tief
 Streuwert: 3.31, horizontal: 4.51, vertikal: 1.24

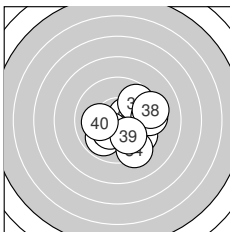

Serie 4: 98.2 (94)

9.7 ↘	10.5* ↗	9.9 ↘	9.3 ↘	9.7 ↗
10.3* ↗	9.4 →	9.3 →	10.0 ↘	10.1 ←

beste Teiler: 120.3 (32.), 158.6 (36.), 219.3 (40.)
 Trefferlage: 1.24 mm rechts, 0.66 mm tief
 Streuwert: 1.99, horizontal: 2.19, vertikal: 1.76



Ergebnis: **405.9** (384)
 Serien: 101.5 99.2 102.1 103.1
 Zähler: 24 16 0 0 0 0 0 0 0 0
 Innenzehner: 21
 Weitester: 401 (38.), 386 (9.), 367 (29.)
 beste Teiler: 5.3 (8.), 20.2 (37.), 52.6 (32.)
 Trefferlage: 0.30 mm rechts, 0.12 mm hoch
 Streuwert: 1.61, horizontal: 1.76, vertikal: 1.45

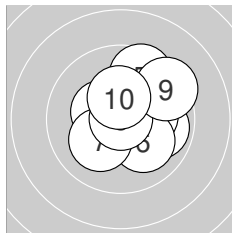
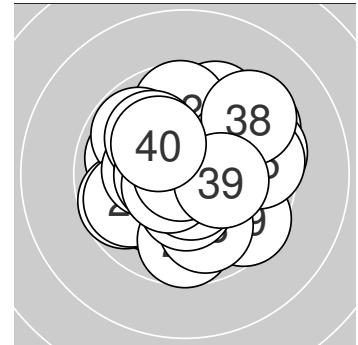

Serie 1: 101.5 (97)

9.9 →	10.2* →	10.6* ↗	10.4* ↖	9.6 ↗
10.1 ↘	10.1 ↙	10.9* ↗	9.4 ↗	10.3* ↑

beste Teiler: 5.3 (8.), 91.0 (3.), 139.4 (4.)
 Trefferlage: 0.83 mm rechts, 0.48 mm hoch
 Streuwert: 1.53, horizontal: 1.57, vertikal: 1.48

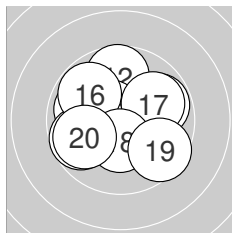

Serie 2: 99.2 (92)

9.9 ↖	9.7 ↑	10.6* ↘	9.8 →	9.7 ↙
9.8 ↘	9.9 ↗	10.4* ↓	9.6 ↘	9.8 ↙

beste Teiler: 95.9 (13.), 145.0 (18.), 257.6 (17.)
 Trefferlage: 0.33 mm links, 0.25 mm hoch
 Streuwert: 1.97, horizontal: 2.23, vertikal: 1.68

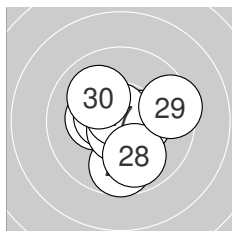

Serie 3: 102.1 (97)

10.4* ↓	10.3* ←	10.4* →	10.5* ↖	9.7 ↓
10.7* ↓	10.7* ↖	9.9 ↓	9.5 →	10.0 ↖

beste Teiler: 54.1 (27.), 68.8 (26.), 114.1 (24.)
 Trefferlage: 0.15 mm rechts, 0.39 mm tief
 Streuwert: 1.54, horizontal: 1.55, vertikal: 1.52

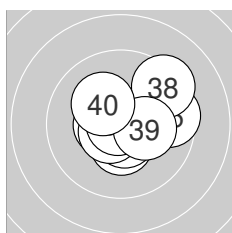

Serie 4: 103.1 (98)

10.4* ↓	10.7* →	10.5* ←	10.6* ↓	9.6 →
10.6* ↙	10.9* ←	9.3 ↗	10.3* →	10.2* ↖

beste Teiler: 20.2 (37.), 52.6 (32.), 90.7 (34.)
 Trefferlage: 0.57 mm rechts, 0.15 mm hoch
 Streuwert: 1.42, horizontal: 1.64, vertikal: 1.16



Ergebnis: **380.5** (362)
 Serien: 95.9 95.4 93.0 96.2
 Zähler: 13 18 7 2 0 0 0 0 0 0
 Innenzehner: 9
 Weitestе: 809 (23.), 781 (14.), 667 (30.)
 beste Teiler: 59.0 (25.), 104.4 (37.), 118.1 (11.)
 Trefferlage: 0.13 mm rechts, 0.24 mm hoch
 Streuwert: 2.88, horizontal: 3.33, vertikal: 2.35

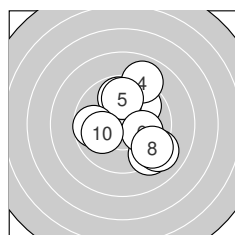
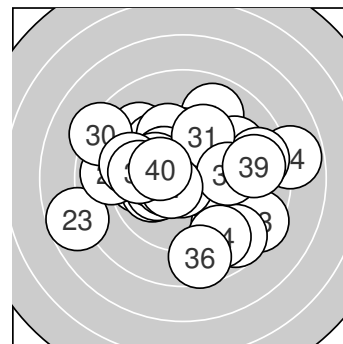

Serie 1: 95.9 (92)

9.9 ↗	9.2 ↘	9.8 ↑	9.0 ↗	9.8 ↑
10.1 ↘	9.1 ↘	9.3 ↘	9.7 ←	10.0 ←

beste Teiler: 224.0 (6.), 236.0 (10.), 275.1 (1.)
 Trefferlage: 1.01 mm rechts, 0.17 mm hoch
 Streuwert: 2.53, horizontal: 2.34, vertikal: 2.70

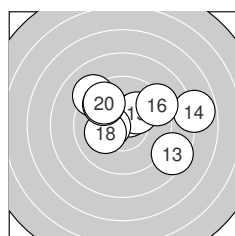

Serie 2: 95.4 (91)

10.5* ↗	9.2 ↘	8.5 ↘	7.8 →	10.2* ↗
9.2 ↗	10.4* ←	10.2* ←	9.7 ↘	9.7 ↘

beste Teiler: 118.1 (11.), 139.9 (17.), 200.5 (15.)
 Trefferlage: 0.84 mm rechts, 0.97 mm hoch
 Streuwert: 2.89, horizontal: 3.65, vertikal: 1.85

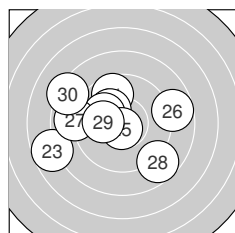

Serie 3: 93.0 (88)

9.6 ↖	10.2* ↘	7.7 ←	10.1 ↘	10.7* ↓
8.7 →	8.9 ←	8.7 ↘	10.1 ←	8.3 ↘

beste Teiler: 59.0 (25.), 196.7 (22.), 209.4 (29.)
 Trefferlage: 1.60 mm links, 0.29 mm hoch
 Streuwert: 3.30, horizontal: 4.03, vertikal: 2.35

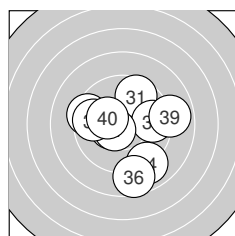

Serie 4: 96.2 (91)

9.6 ↗	10.4* ←	9.7 →	9.0 ↘	9.4 ←
8.7 ↓	10.5* ↗	9.7 ←	8.9 →	10.3* ↘

beste Teiler: 104.4 (37.), 134.4 (32.), 175.8 (40.)
 Trefferlage: 0.29 mm rechts, 0.45 mm tief
 Streuwert: 2.73, horizontal: 2.88, vertikal: 2.57



Ergebnis: **379.0** (361)
 Serien: 96.3 93.3 96.6 92.8
 Zähler: 14 19 4 0 3 0 0 0 0 0 0
 Innenzehner: 12
 Weitester: 1132 (17.), 1060 (11.), 1045 (40.)
 beste Teiler: 45.3 (35.), 69.5 (12.), 75.7 (14.)
 Trefferlage: 1.05 mm rechts, 1.45 mm tief
 Streuwert: 2.96, horizontal: 3.49, vertikal: 2.32

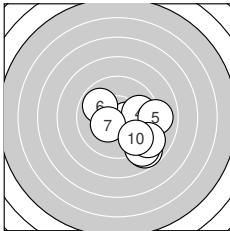
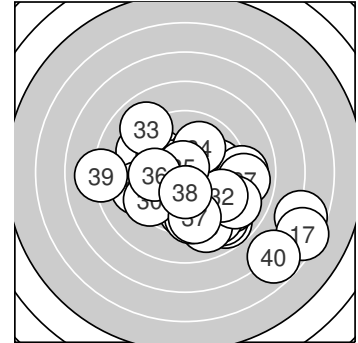

Serie 1: 96.3 (91)

8.8 ↘	10.5* ↙	10.5* →	9.8 →	9.0 →
9.9 ↖	10.3* ↗	8.9 ↘	9.0 ↘	9.6 ↘

beste Teiler: 117.8 (3.), 118.1 (2.), 154.4 (7.)
 Trefferlage: 1.70 mm rechts, 1.35 mm tief
 Streuwert: 2.22, horizontal: 2.44, vertikal: 1.97

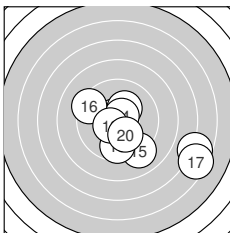

Serie 2: 93.3 (89)

6.7 →	10.7* ↖	10.2* ↗	10.7* ↗	9.1 ↘
9.3 ↖	6.4 ↘	9.6 ↓	10.5* ↙	10.1 ↘

beste Teiler: 69.5 (12.), 75.7 (14.), 113.8 (19.)
 Trefferlage: 1.98 mm rechts, 1.44 mm tief
 Streuwert: 3.65, horizontal: 4.50, vertikal: 2.52

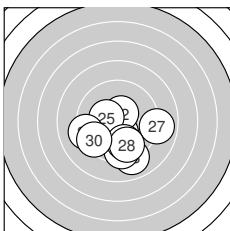

Serie 3: 96.6 (92)

10.4* ↓	10.5* ↑	9.0 ↓	9.4 ↓	10.3* ↖
9.8 ↓	8.9 →	9.7 ↓	9.2 ←	9.4 ↗

beste Teiler: 109.2 (22.), 147.8 (21.), 151.4 (25.)
 Trefferlage: 0.16 mm rechts, 1.84 mm tief
 Streuwert: 2.21, horizontal: 2.55, vertikal: 1.80

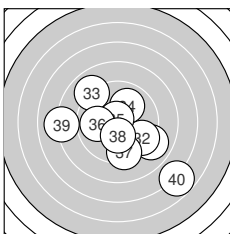

Serie 4: 92.8 (89)

9.0 ↘	9.5 ↘	9.0 ↖	10.0 ↗	10.8* ↖
9.9 ←	9.4 ↓	10.3* ↓	8.1 ←	6.8 ↘

beste Teiler: 45.3 (35.), 171.0 (38.), 239.7 (34.)
 Trefferlage: 0.38 mm rechts, 1.16 mm tief
 Streuwert: 3.65, horizontal: 4.15, vertikal: 3.08



Ergebnis: **403.6** (386)
 Serien: 99.6 98.9 100.9 104.2
 Zähler: 27 12 1 0 0 0 0 0 0 0
 Innenezehner: 22
 Weitester: 607 (13.), 453 (11.), 427 (10.)
 beste Teiler: 17.2 (32.), 72.2 (22.), 76.8 (7.)
 Trefferlage: 0.08 mm rechts, 0.22 mm tief
 Streuwert: 1.78, horizontal: 2.09, vertikal: 1.40

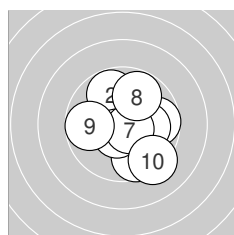
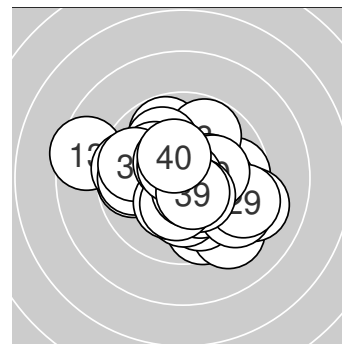

Serie 1: 99.6 (94)

10.4* →	9.8 ↘	9.7 →	9.7 ↓	10.1 →
10.6* ↙	10.6* ↘	9.8 ↗	9.7 ←	9.2 ↓

beste Teiler: 76.8 (7.), 99.1 (6.), 142.4 (1.)
 Trefferlage: 0.79 mm rechts, 0.20 mm tief
 Streuwert: 1.91, horizontal: 1.87, vertikal: 1.96

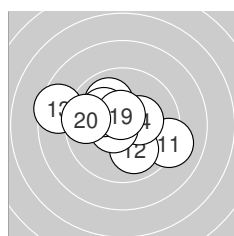

Serie 2: 98.9 (96)

9.1 →	10.0 ↓	8.5 ←	10.3* →	10.1 ↖
10.0 ↘	10.6* ←	10.1 ↖	10.6* ↑	9.6 ←

beste Teiler: 86.6 (17.), 95.5 (19.), 156.6 (14.)
 Trefferlage: 0.84 mm links, 0.36 mm hoch
 Streuwert: 2.18, horizontal: 2.78, vertikal: 1.36

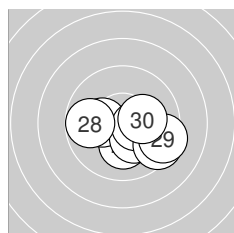

Serie 3: 100.9 (97)

10.2* ↓	10.7* ↓	10.2* ↓	10.2* ←	10.3* ↓
10.5* →	9.4 ↘	9.8 ←	9.4 →	10.2* →

beste Teiler: 72.2 (22.), 124.9 (26.), 175.8 (25.)
 Trefferlage: 0.77 mm rechts, 0.86 mm tief
 Streuwert: 1.57, horizontal: 2.05, vertikal: 0.87

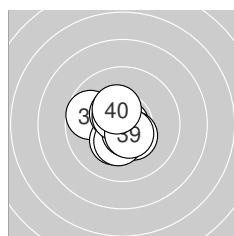

Serie 4: 104.2 (99)

9.7 ←	10.9* →	10.4* ↓	10.3* ↙	10.5* ↘
10.3* ↓	10.6* ↓	10.6* ↘	10.5* ↓	10.4* ↗

beste Teiler: 17.2 (32.), 81.4 (37.), 90.6 (38.)
 Trefferlage: 0.39 mm links, 0.18 mm tief
 Streuwert: 1.08, horizontal: 1.08, vertikal: 1.09



Ergebnis: **384.4** (369)
 Serien: 97.4 95.5 92.6 98.9
 Zähler: 19 13 6 2 0 0 0 0 0 0
 Innenezehner: 12
 Weitester: 947 (15.), 899 (28.), 710 (6.)
 beste Teiler: 33.1 (20.), 55.0 (2.), 65.1 (25.)
 Trefferlage: 0.00 mm , 0.23 mm tief
 Streuwert: 2.89, horizontal: 3.78, vertikal: 1.55

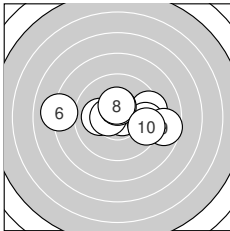
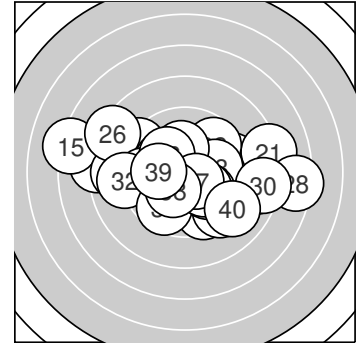

Serie 1: 97.4 (93)

10.1 ←	10.7* →	9.4 →	10.5* ←	9.6 →
8.1 ←	10.4* ↑	10.4* ↑	8.7 →	9.5 →

beste Teiler: 55.0 (2.), 113.0 (4.), 127.0 (7.)
 Trefferlage: 0.63 mm rechts, 0.15 mm hoch
 Streuwert: 2.68, horizontal: 3.67, vertikal: 0.91

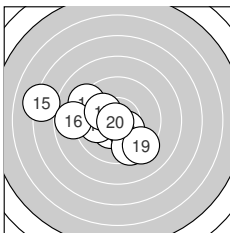

Serie 2: 95.5 (91)

10.4* ↙	10.3* ↘	9.9 ←	9.2 ↖	7.2 ←
8.8 ←	10.1 ↖	9.5 ↘	9.3 ↘	10.8* ↙

beste Teiler: 33.1 (20.), 144.6 (11.), 151.4 (12.)
 Trefferlage: 1.84 mm links, 0.38 mm tief
 Streuwert: 2.86, horizontal: 3.59, vertikal: 1.85

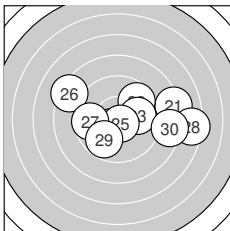

Serie 3: 92.6 (88)

8.2 →	9.7 ↗	10.0 →	10.5* ↙	10.7* ↘
8.3 ↖	9.6 ←	7.4 →	9.8 ↙	8.4 →

beste Teiler: 65.1 (25.), 125.8 (24.), 245.2 (23.)
 Trefferlage: 1.55 mm rechts, 0.11 mm hoch
 Streuwert: 3.56, horizontal: 4.73, vertikal: 1.72

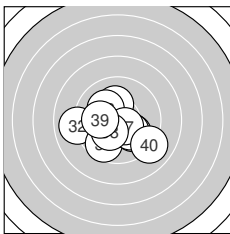

Serie 4: 98.9 (97)

10.2* ↑	9.0 ←	9.6 ↙	10.0 ↘	10.1 ↘
10.1 ↖	10.5* ↘	10.3* ↙	10.1 ←	9.0 ↘

beste Teiler: 115.7 (37.), 170.5 (38.), 193.4 (31.)
 Trefferlage: 0.32 mm links, 0.81 mm tief
 Streuwert: 2.07, horizontal: 2.46, vertikal: 1.60



Ergebnis: **400.2** (381)
 Serien: 100.5 101.3 98.4 100.0
 Zähler: 23 15 2 0 0 0 0 0 0 0
 Innenezehner: 18
 Weitestе: 538 (20.), 527 (4.), 473 (2.)
 beste Teiler: 21.3 (12.), 22.3 (19.), 44.0 (3.)
 Trefferlage: 0.03 mm rechts, 1.37 mm tief
 Streuwert: 1.63, horizontal: 1.68, vertikal: 1.59

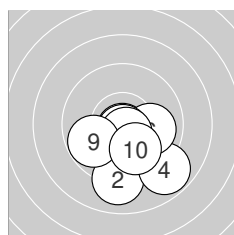
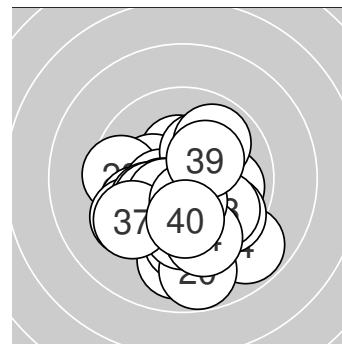

Serie 1: 100.5 (96)

10.3* ↘	9.1 ↓	10.8* ↓	8.8 ↘	10.4* ↘
10.0 →	10.7* ↓	10.6* ↓	9.8 ↙	10.0 ↓

beste Teiler: 44.0 (3.), 54.0 (7.), 83.9 (8.)
 Trefferlage: 0.63 mm rechts, 1.68 mm tief
 Streuwert: 1.56, horizontal: 1.64, vertikal: 1.48

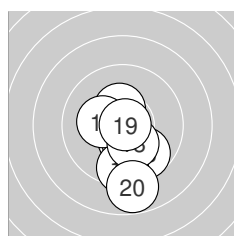

Serie 2: 101.3 (96)

10.4* ↓	10.9* ↓	9.7 ↘	10.2* ↓	10.4* ↑
9.5 ↓	10.3* ←	10.2* ↓	10.9* →	8.8 ↓

beste Teiler: 21.3 (12.), 22.3 (19.), 129.3 (11.)
 Trefferlage: 0.24 mm rechts, 1.44 mm tief
 Streuwert: 1.56, horizontal: 0.93, vertikal: 2.00

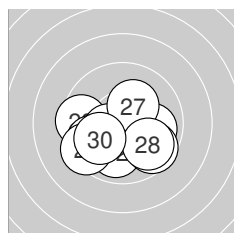

Serie 3: 98.4 (93)

9.9 →	9.9 ↓	9.5 ←	10.4* ↙	9.6 ↘
9.7 ↙	10.2* ↗	9.8 ↘	9.4 ↙	10.0 ↙

beste Teiler: 132.8 (24.), 176.6 (27.), 237.1 (30.)
 Trefferlage: 0.49 mm links, 1.08 mm tief
 Streuwert: 1.90, horizontal: 2.38, vertikal: 1.25

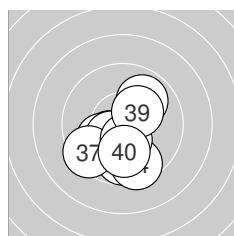

Serie 4: 100.0 (96)

10.3* ↙	9.7 ↓	9.9 ↗	9.5 ↓	10.1 ↙
10.4* ↙	9.4 ↙	10.4* ↓	10.3* ↗	10.0 ↓

beste Teiler: 136.5 (38.), 150.1 (36.), 157.0 (31.)
 Trefferlage: 0.22 mm links, 1.29 mm tief
 Streuwert: 1.60, horizontal: 1.47, vertikal: 1.72



Ergebnis: **387.0** (370)
 Serien: 97.1 96.7 97.7 95.5
 Zähler: 17 18 3 2 0 0 0 0 0 0
 Innenzehner: 11
 Weitester: 857 (38.), 810 (20.), 647 (3.)
 beste Teiler: 29.7 (34.), 130.5 (1.), 145.8 (2.)
 Trefferlage: 0.33 mm links, 0.12 mm tief
 Streuwert: 2.58, horizontal: 2.91, vertikal: 2.18

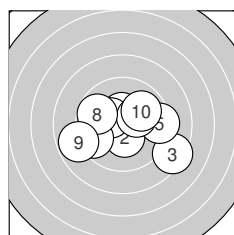
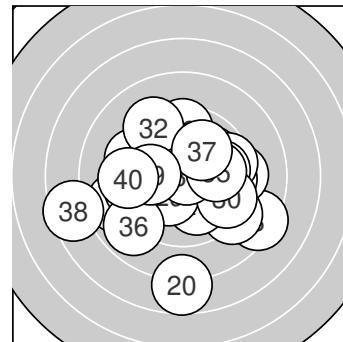

Serie 1: 97.1 (92)

10.4* ↑	10.4* ↓	8.4 ↘	10.4* ↖	9.3 →
9.5 ↙	10.3* ↗	9.7 ↖	8.8 ↙	9.9 ↗

beste Teiler: 130.5 (1.), 145.8 (2.), 150.7 (4.)
 Trefferlage: 0.11 mm rechts, 0.27 mm tief
 Streuwert: 2.63, horizontal: 3.32, vertikal: 1.66

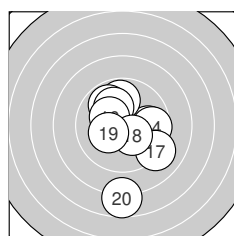

Serie 2: 96.7 (92)

9.8 →	9.8 ↑	9.8 ↘	9.6 →	10.1 ↘
10.3* ↖	9.1 ↘	10.3* ↘	10.2* ↙	7.7 ↓

beste Teiler: 155.5 (18.), 173.4 (16.), 178.9 (19.)
 Trefferlage: 0.48 mm rechts, 0.52 mm tief
 Streuwert: 2.69, horizontal: 2.09, vertikal: 3.17

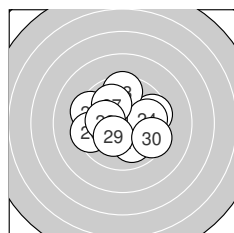

Serie 3: 97.7 (94)

10.0 ↓	9.6 →	9.5 ↑	9.8 →	9.4 ↖
9.5 ↙	10.0 ↘	10.2* ↖	10.2* ↙	9.5 ↘

beste Teiler: 177.8 (29.), 196.1 (28.), 237.4 (21.)
 Trefferlage: 0.10 mm links, 0.24 mm hoch
 Streuwert: 2.26, horizontal: 2.63, vertikal: 1.81

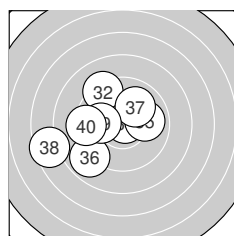

Serie 4: 95.5 (92)

9.5 ↙	9.3 ↘	10.2* ↗	10.8* ↗	10.0 →
8.9 ↙	10.0 ↗	7.5 ↙	10.0 ↖	9.3 ↖

beste Teiler: 29.7 (34.), 195.8 (33.), 239.0 (37.)
 Trefferlage: 1.82 mm links, 0.04 mm hoch
 Streuwert: 2.75, horizontal: 3.31, vertikal: 2.06



Ergebnis: **371.6** (354)
 Serien: 92.0 94.9 90.8 93.9
 Zähler: 9 18 11 2 0 0 0 0 0 0 0
 Innenzehner: 5
 Weitester: 915 (10.), 847 (27.), 713 (18.)
 beste Teiler: 16.0 (16.), 24.4 (33.), 57.9 (5.)
 Trefferlage: 0.54 mm rechts, 0.80 mm tief
 Streuwert: 3.27, horizontal: 3.81, vertikal: 2.62

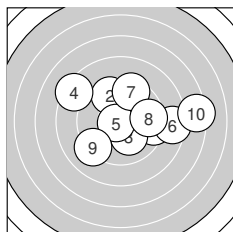
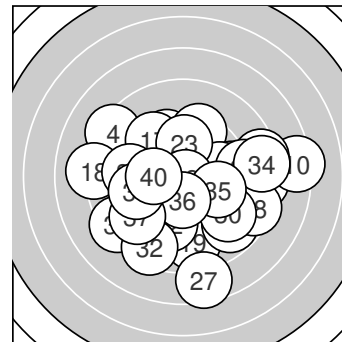

Serie 1: 92.0 (88)

9.4 →	9.6 ↖	10.1 ↘	8.3 ↖	10.7* ←
8.5 →	9.4 ↑	9.6 →	9.1 ↗	7.3 →

beste Teiler: 57.9 (5.), 207.1 (3.), 333.9 (2.)
 Trefferlage: 1.41 mm rechts, 0.52 mm hoch
 Streuwert: 3.51, horizontal: 4.41, vertikal: 2.26

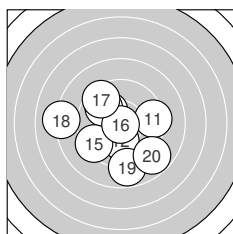

Serie 2: 94.9 (90)

9.4 →	10.1 ↓	10.1 ↘	9.9 ↖	9.3 ↗
10.9* ↓	9.5 ↖	8.1 ←	8.8 ↓	8.8 ↘

beste Teiler: 16.0 (16.), 202.3 (13.), 210.0 (12.)
 Trefferlage: 0.76 mm links, 0.66 mm tief
 Streuwert: 2.98, horizontal: 3.28, vertikal: 2.64

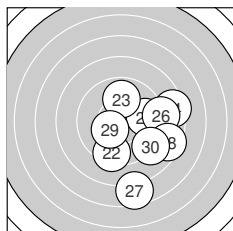

Serie 3: 90.8 (86)

9.8 →	9.4 ↓	9.9 ↑	8.4 →	8.8 ↘
9.0 →	7.6 ↓	8.5 ↘	10.3* ↗	9.1 ↘

beste Teiler: 161.0 (29.), 265.1 (23.), 297.0 (21.)
 Trefferlage: 2.76 mm rechts, 1.52 mm tief
 Streuwert: 2.98, horizontal: 2.78, vertikal: 3.17

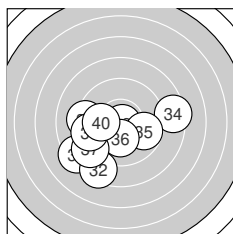

Serie 4: 93.9 (90)

8.4 ↖	8.5 ↙	10.9* ↘	8.4 →	9.8 ↘
10.2* ↓	9.0 ↗	9.3 ←	9.4 ←	10.0 ←

beste Teiler: 24.4 (33.), 192.0 (36.), 234.0 (40.)
 Trefferlage: 1.25 mm links, 1.57 mm tief
 Streuwert: 2.95, horizontal: 3.60, vertikal: 2.10



Ergebnis: **363.5** (347)
 Serien: 89.5 91.4 89.6 93.0
 Zähler: 6 22 7 3 2 0 0 0 0 0 0
 Innenzehner: 4
 Weitester: 1183 (24.), 1137 (5.), 875 (34.)
 beste Teiler: 97.4 (40.), 112.3 (39.), 152.8 (21.)
 Trefferlage: 1.53 mm links, 0.42 mm hoch
 Streuwert: 3.62, horizontal: 3.98, vertikal: 3.22

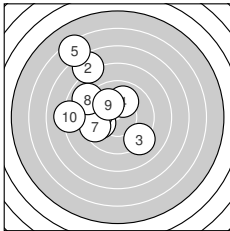
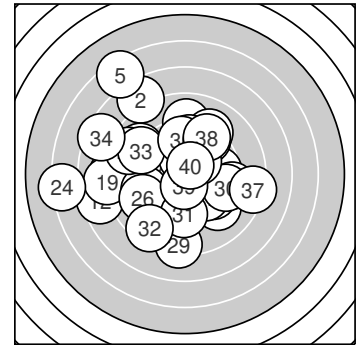

Serie 1: 89.5 (85)

9.9 ←	7.6 ↘	9.2 ↘	10.0 ↑	6.4 ↘
9.7 ←	9.6 ←	8.9 ↘	10.0 ↘	8.2 ←

beste Teiler: 226.4 (9.), 236.8 (4.), 264.0 (1.)
 Trefferlage: 2.78 mm links, 1.84 mm hoch
 Streuwert: 3.48, horizontal: 3.04, vertikal: 3.88

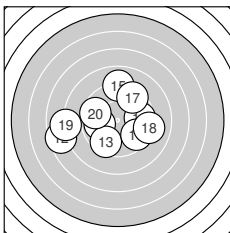

Serie 2: 91.4 (87)

9.9 ←	7.6 ←	9.5 ↘	9.7 →	9.0 ↑
9.6 ↘	9.4 ↗	9.1 →	8.0 ←	9.6 ←

beste Teiler: 263.0 (11.), 320.9 (14.), 334.9 (20.)
 Trefferlage: 1.03 mm links, 0.04 mm tief
 Streuwert: 3.58, horizontal: 4.38, vertikal: 2.55

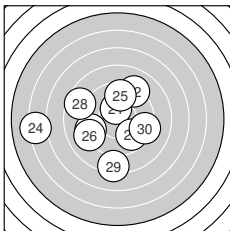

Serie 3: 89.6 (86)

10.3* ↑	9.1 ↗	9.3 ←	6.2 ←	9.6 ↑
9.1 ←	9.8 ↘	8.6 ↘	8.3 ↓	9.3 →

beste Teiler: 152.8 (21.), 297.4 (27.), 344.3 (25.)
 Trefferlage: 1.72 mm links, 0.41 mm tief
 Streuwert: 4.00, horizontal: 4.65, vertikal: 3.23

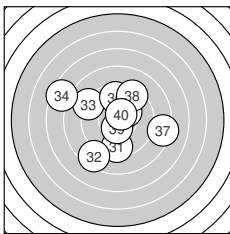

Serie 4: 93.0 (89)

9.4 ↓	8.5 ↘	9.0 ↘	7.5 ↘	10.3* ↗
9.6 ↑	8.3 →	9.3 ↗	10.5* ↓	10.6* ↗

beste Teiler: 97.4 (40.), 112.3 (39.), 172.5 (35.)
 Trefferlage: 0.57 mm links, 0.30 mm hoch
 Streuwert: 3.54, horizontal: 3.92, vertikal: 3.10



Ergebnis: **378.3** (362)
 Serien: 92.7 91.2 96.0 98.4
 Zähler: 11 21 7 1 0 0 0 0 0 0
 Innenezehner: 5
 Weitestе: 798 (9.), 661 (11.), 646 (13.)
 beste Teiler: 59.2 (2.), 85.4 (28.), 116.1 (36.)
 Trefferlage: 0.18 mm links, 1.46 mm hoch
 Streuwert: 2.73, horizontal: 3.11, vertikal: 2.30

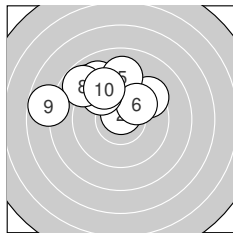
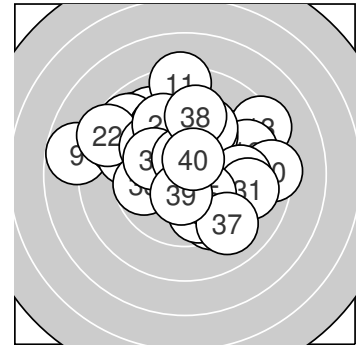

Serie 1: 92.7 (88)

9.4 ↗	10.7* ↑	8.9 ↘	9.0 ↘	9.1 ↑
10.0 ↗	9.6 ↘	8.8 ↘	7.8 ←	9.4 ↘

beste Teiler: 59.2 (2.), 240.5 (6.), 340.8 (7.)
 Trefferlage: 1.67 mm links, 2.81 mm hoch
 Streuwert: 2.39, horizontal: 3.12, vertikal: 1.28

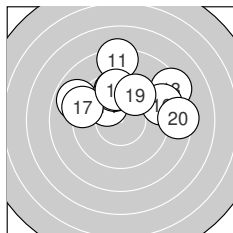

Serie 2: 91.2 (87)

8.3 ↑	8.9 ↘	8.4 ↗	10.1 ↘	9.6 ↑
9.0 ↗	9.2 ↘	9.6 ↑	9.7 ↗	8.4 →

beste Teiler: 215.8 (14.), 318.8 (19.), 327.7 (15.)
 Trefferlage: 0.59 mm rechts, 2.64 mm hoch
 Streuwert: 2.96, horizontal: 3.82, vertikal: 1.72

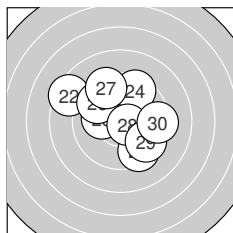

Serie 3: 96.0 (92)

10.1 ↘	8.4 ↘	10.1 ←	9.5 ↗	9.4 ↘
9.7 ↘	9.4 ↑	10.6* ↘	9.5 ↘	9.3 →

beste Teiler: 85.4 (28.), 205.2 (23.), 222.2 (21.)
 Trefferlage: 0.24 mm links, 0.73 mm hoch
 Streuwert: 2.64, horizontal: 2.94, vertikal: 2.30

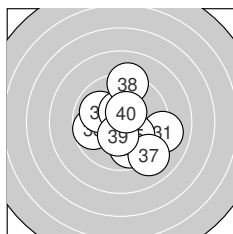

Serie 4: 98.4 (95)

9.1 →	9.8 ↓	9.7 ←	10.0 ↘	10.1 ↘
10.5* ↑	9.1 ↘	9.2 ↑	10.4* ↓	10.5* ↗

beste Teiler: 116.1 (36.), 123.5 (40.), 146.5 (39.)
 Trefferlage: 0.58 mm rechts, 0.34 mm tief
 Streuwert: 2.25, horizontal: 2.23, vertikal: 2.27



Ergebnis: **388.2** (374)
 Serien: 94.6 96.6 96.5 100.5
 Zähler: 19 17 3 1 0 0 0 0 0 0
 Innenezehner: 13
 Weitester: 971 (20.), 685 (19.), 612 (23.)
 beste Teiler: 21.4 (22.), 52.0 (34.), 105.0 (37.)
 Trefferlage: 0.79 mm links, 0.27 mm tief
 Streuwert: 2.55, horizontal: 2.86, vertikal: 2.19

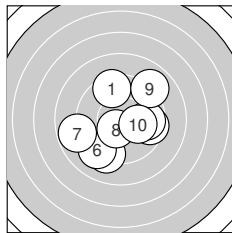
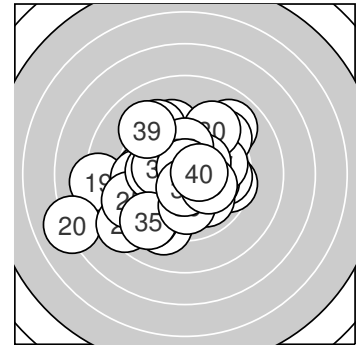

Serie 1: 94.6 (91)

9.5 ↗	9.2 ↘	9.2 ↘	9.5 →	9.7 →
9.1 ↘	8.8 ↙	10.5* ↘	9.0 ↗	10.1 →

beste Teiler: 125.2 (8.), 212.0 (10.), 304.6 (5.)
 Trefferlage: 0.17 mm links, 0.83 mm tief
 Streuwert: 2.87, horizontal: 3.01, vertikal: 2.72

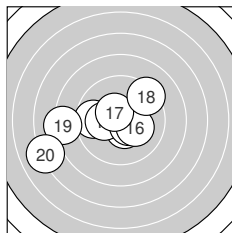

Serie 2: 96.6 (93)

10.4* →	9.7 ←	10.5* ↘	10.2* ←	10.5* ↘
10.2* →	10.5* ↖	9.3 ↗	8.2 ←	7.1 ↙

beste Teiler: 118.4 (17.), 118.7 (13.), 119.0 (15.)
 Trefferlage: 1.42 mm links, 0.30 mm tief
 Streuwert: 2.99, horizontal: 3.86, vertikal: 1.72

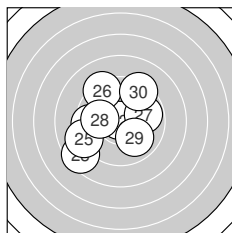

Serie 3: 96.5 (92)

10.3* ↖	10.9* ↖	8.5 ↘	9.5 ←	9.0 ↙
9.3 ↖	9.8 →	10.0 ←	9.9 ↘	9.3 ↗

beste Teiler: 21.4 (22.), 159.7 (21.), 246.1 (28.)
 Trefferlage: 1.25 mm links, 0.06 mm hoch
 Streuwert: 2.53, horizontal: 2.70, vertikal: 2.34

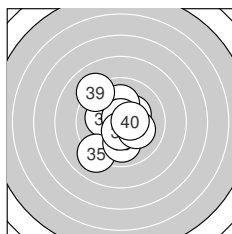

Serie 4: 100.5 (98)

10.1 ←	10.3* ↗	10.1 ↑	10.7* ↑	9.1 ↘
10.0 ↓	10.5* ↓	10.1 →	9.1 ↖	10.5* →

beste Teiler: 52.0 (34.), 105.0 (37.), 112.7 (40.)
 Trefferlage: 0.33 mm links, 0.02 mm tief
 Streuwert: 1.92, horizontal: 1.71, vertikal: 2.10



Ergebnis: **355.6** (334)
 Serien: 90.4 90.7 88.3 86.2
 Zähler: 5 17 11 3 2 2 0 0 0 0 0
 Innenzehner: 5
 Weitester: 1437 (24.), 1292 (32.), 1168 (34.)
 beste Teiler: 6.3 (23.), 75.1 (16.), 144.5 (28.)
 Trefferlage: 0.45 mm links, 0.88 mm tief
 Streuwert: 4.27, horizontal: 3.35, vertikal: 5.02

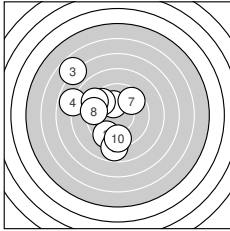
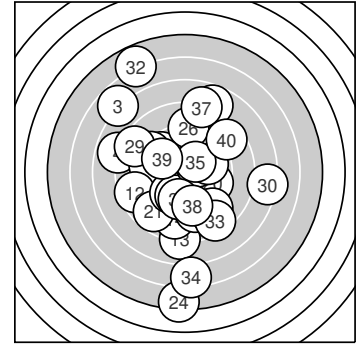

Serie 1: 90.4 (85)

10.2* ↖	9.5 ↙	6.8 ↘	7.9 ↖	9.6 ↘
9.2 ↘	9.6 ↗	9.4 ↖	8.8 ↓	9.4 ↓

beste Teiler: 195.9 (1.), 332.3 (7.), 344.1 (5.)
 Trefferlage: 2.59 mm links, 0.65 mm hoch
 Streuwert: 3.47, horizontal: 3.15, vertikal: 3.76

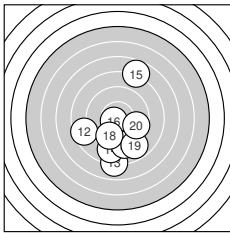

Serie 2: 90.7 (85)

9.7 ↓	8.6 ↖	8.0 ↓	8.8 ↓	7.7 ↑
10.7* ↖	9.1 ↓	9.7 ↓	8.8 ↘	9.6 ↘

beste Teiler: 75.1 (16.), 320.7 (18.), 323.5 (11.)
 Trefferlage: 0.01 mm links, 2.38 mm tief
 Streuwert: 3.39, horizontal: 2.67, vertikal: 3.99

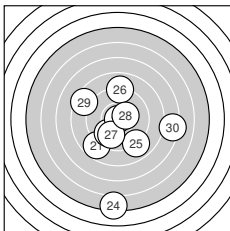

Serie 3: 88.3 (83)

8.7 ↙	9.8 ↙	10.9* →	5.2 ↓	8.9 ↘
9.0 ↑	9.8 ↓	10.4* →	8.4 ↖	7.2 →

beste Teiler: 6.3 (23.), 144.5 (28.), 280.2 (27.)
 Trefferlage: 0.15 mm rechts, 2.05 mm tief
 Streuwert: 4.64, horizontal: 3.98, vertikal: 5.22

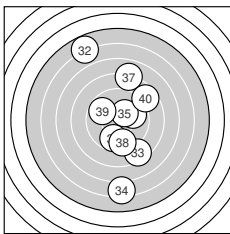

Serie 4: 86.2 (81)

9.9 →	5.8 ↖	8.4 ↘	6.3 ↓	10.3* ↗
9.7 ↓	8.0 ↑	9.4 ↓	9.8 ↖	8.6 ↗

beste Teiler: 164.0 (35.), 270.0 (31.), 294.9 (39.)
 Trefferlage: 0.63 mm rechts, 0.23 mm hoch
 Streuwert: 5.12, horizontal: 2.94, vertikal: 6.62



Ergebnis: **384.7** (365)
 Serien: 95.0 97.9 96.1 95.7
 Zähler: 16 15 8 0 1 0 0 0 0 0 0
 Innenzehner: 13
 Weitester: 1136 (34.), 747 (5.), 659 (2.)
 beste Teiler: 56.0 (9.), 87.1 (4.), 129.6 (29.)
 Trefferlage: 0.79 mm links, 0.49 mm hoch
 Streuwert: 2.75, horizontal: 2.88, vertikal: 2.61

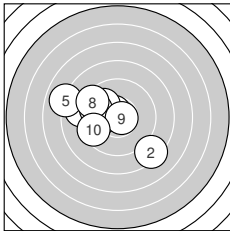
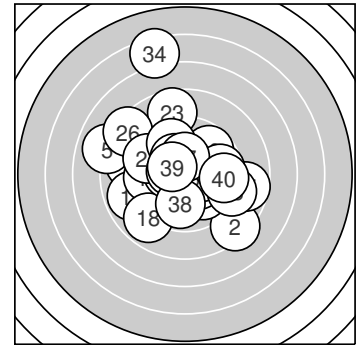

Serie 1: 95.0 (90)

8.9 ←	8.3 ↘	10.1 ←	10.6* ↗	8.0 ←
9.9 ↘	9.7 ↖	9.3 ↘	10.7* →	9.5 ↗

beste Teiler: 56.0 (9.), 87.1 (4.), 216.1 (3.)
 Trefferlage: 2.11 mm links, 0.22 mm hoch
 Streuwert: 2.71, horizontal: 3.19, vertikal: 2.11

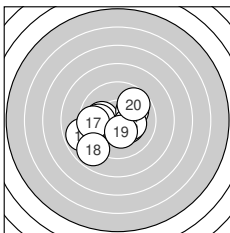

Serie 2: 97.9 (93)

10.1 ←	10.3* ↘	9.9 ←	10.0 ↗	8.9 ←
10.2* →	9.6 ←	8.9 ↗	10.3* ↓	9.7 ↗

beste Teiler: 163.6 (19.), 164.2 (12.), 178.3 (16.)
 Trefferlage: 0.85 mm links, 0.55 mm tief
 Streuwert: 2.24, horizontal: 2.66, vertikal: 1.72

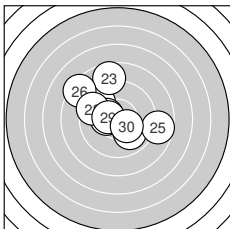

Serie 3: 96.1 (91)

9.6 ↘	10.3* ↖	8.7 ↑	9.9 ↘	8.7 →
8.4 ↘	10.3* ←	9.5 ↖	10.4* ←	10.3* ↘

beste Teiler: 129.6 (29.), 152.0 (27.), 157.6 (30.)
 Trefferlage: 0.81 mm links, 1.00 mm hoch
 Streuwert: 2.69, horizontal: 2.99, vertikal: 2.35

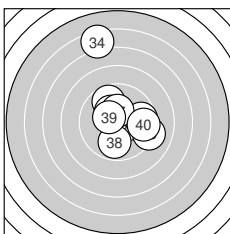

Serie 4: 95.7 (91)

9.7 ↘	10.4* →	10.3* ↘	6.4 ↑	9.1 →
9.7 →	10.3* ↑	9.9 ↓	10.4* ↖	9.5 →

beste Teiler: 134.8 (39.), 140.8 (32.), 156.0 (37.)
 Trefferlage: 0.58 mm rechts, 1.30 mm hoch
 Streuwert: 3.15, horizontal: 2.39, vertikal: 3.76



Ergebnis: **368.4** (350)
 Serien: 92.6 91.0 87.4 97.4
 Zähler: 13 11 10 5 1 0 0 0 0 0 0
 Innenzehner: 7
 Weitester: 1151 (1.), 994 (17.), 966 (22.)
 beste Teiler: 23.7 (35.), 30.0 (39.), 40.4 (33.)
 Trefferlage: 0.98 mm links, 0.47 mm hoch
 Streuwert: 3.63, horizontal: 4.65, vertikal: 2.19

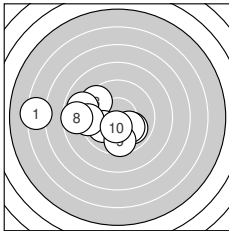
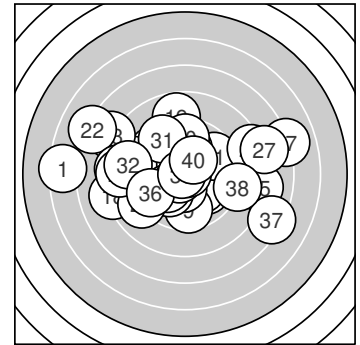

Serie 1: 92.6 (88)

6.3 ←	9.9 ↘	9.5 ↘	10.0 ↙	8.9 ←
10.1 ↘	9.3 ←	8.6 ←	9.6 ↓	10.4* ↓

beste Teiler: 136.4 (10.), 211.2 (6.), 240.2 (4.)
 Trefferlage: 2.76 mm links, 0.52 mm tief
 Streuwert: 3.10, horizontal: 4.09, vertikal: 1.60

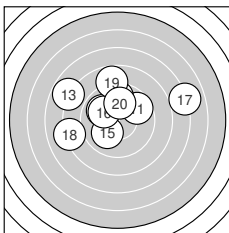

Serie 2: 91.0 (87)

9.7 ↗	9.6 ↑	7.8 ↘	9.9 ↘	10.0 ↗
10.1 ↘	7.0 →	8.1 ←	8.8 ↑	10.0 ↑

beste Teiler: 224.3 (16.), 227.2 (15.), 242.9 (20.)
 Trefferlage: 0.75 mm links, 1.82 mm hoch
 Streuwert: 3.69, horizontal: 4.68, vertikal: 2.31

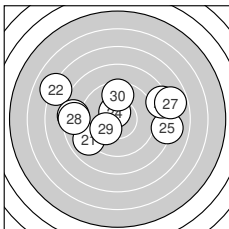

Serie 3: 87.4 (84)

9.0 ↙	7.1 ↘	8.4 ←	10.5* ↘	8.1 →
8.3 →	7.8 →	8.5 ←	10.1 ↙	9.6 ↑

beste Teiler: 109.0 (24.), 213.9 (29.), 341.0 (30.)
 Trefferlage: 0.65 mm links, 0.85 mm hoch
 Streuwert: 4.45, horizontal: 5.88, vertikal: 2.25

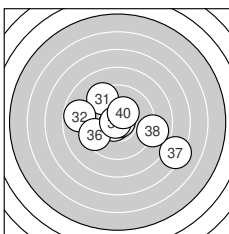

Serie 4: 97.4 (91)

9.4 ↘	8.8 ←	10.8* ↙	10.7* ↙	10.9* →
9.5 ↙	7.3 ↘	8.9 →	10.8* ←	10.3* ↗

beste Teiler: 23.7 (35.), 30.0 (39.), 40.4 (33.)
 Trefferlage: 0.22 mm rechts, 0.23 mm tief
 Streuwert: 3.09, horizontal: 3.88, vertikal: 2.01



Ergebnis: **357.2** (344)
 Serien: 91.5 91.6 84.5 89.6
 Zähler: 7 20 5 6 2 0 0 0 0 0 0
 Innenzehner: 3
 Weitester: 1077 (29.), 1010 (31.), 997 (16.)
 beste Teiler: 111.2 (13.), 111.8 (6.), 155.3 (36.)
 Trefferlage: 0.11 mm links, 2.01 mm hoch
 Streuwert: 3.85, horizontal: 3.79, vertikal: 3.92

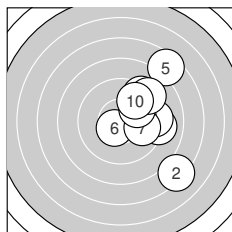
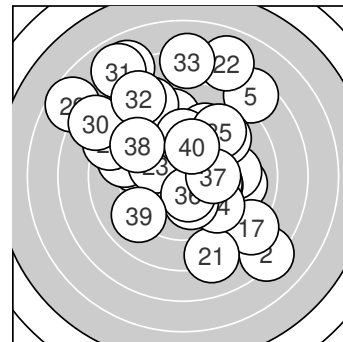

Serie 1: 91.5 (88)

9.3 ↗	7.2 ↘	9.1 →	9.3 →	7.5 ↗
10.5* ↗	9.8 →	10.0 ↗	9.1 ↗	9.7 ↗

beste Teiler: 111.8 (6.), 250.6 (8.), 276.3 (7.)
 Trefferlage: 3.28 mm rechts, 0.87 mm hoch
 Streuwert: 2.88, horizontal: 2.16, vertikal: 3.45

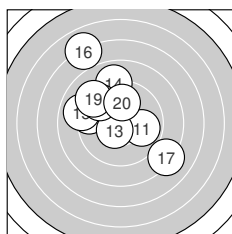

Serie 2: 91.6 (88)

9.9 →	9.4 ←	10.5* ↗	9.0 ↑	9.0 ←
7.0 ↘	8.2 ↘	9.5 ↘	9.2 ↘	9.9 ↑

beste Teiler: 111.2 (13.), 254.6 (20.), 266.3 (11.)
 Trefferlage: 1.22 mm links, 1.85 mm hoch
 Streuwert: 3.43, horizontal: 3.34, vertikal: 3.52

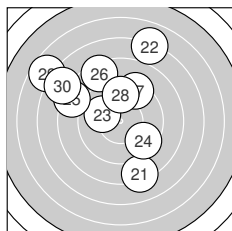

Serie 3: 84.5 (81)

8.2 ↓	7.0 ↑	10.0 ←	9.5 ↘	8.3 ←
8.4 ↘	9.3 ↑	9.6 ↑	6.6 ↘	7.6 ↘

beste Teiler: 239.9 (23.), 326.0 (28.), 368.7 (24.)
 Trefferlage: 1.65 mm links, 2.70 mm hoch
 Streuwert: 4.49, horizontal: 4.51, vertikal: 4.48

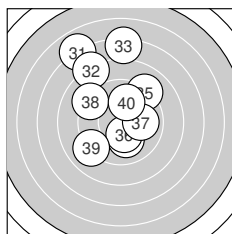

Serie 4: 89.6 (87)

6.9 ↘	8.0 ↘	7.2 ↑	10.1 ↓	9.1 ↗
10.3* ↓	10.0 →	9.1 ↘	9.0 ↗	9.9 ↑

beste Teiler: 155.3 (36.), 222.0 (34.), 248.0 (37.)
 Trefferlage: 0.86 mm links, 2.62 mm hoch
 Streuwert: 3.76, horizontal: 2.92, vertikal: 4.44



Ergebnis: **385.8** (367)
 Serien: 97.3 97.3 92.7 98.5
 Zähler: 18 14 5 3 0 0 0 0 0 0
 Innenezehner: 12
 Weitester: 904 (21.), 823 (15.), 758 (28.)
 beste Teiler: 105.5 (14.), 114.5 (13.), 121.2 (11.)
 Trefferlage: 0.85 mm links, 0.80 mm tief
 Streuwert: 2.58, horizontal: 3.00, vertikal: 2.09

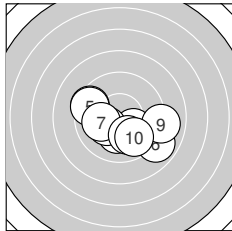
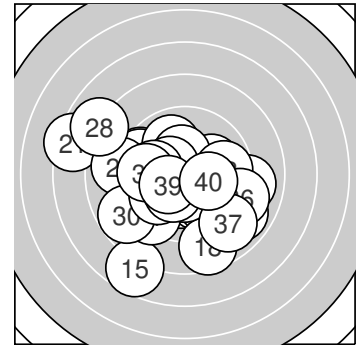

Serie 1: 97.3 (94)

9.5 ↖	10.2* ↓	10.1 ↘	10.2* ↖	9.5 ↖
8.9 ↘	10.1 ↖	10.0 ↓	9.0 →	9.8 ↘

beste Teiler: 180.0 (4.), 197.1 (2.), 203.2 (3.)
 Trefferlage: 0.24 mm rechts, 1.02 mm tief
 Streuwert: 2.31, horizontal: 2.93, vertikal: 1.44

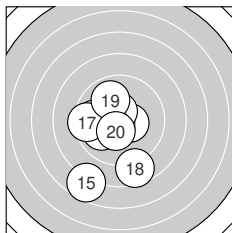

Serie 2: 97.3 (92)

10.5* →	10.0 ↖	10.5* ↖	10.5* ↑	7.7 ↓
9.8 ↖	9.4 ↖	8.6 ↓	9.9 ↗	10.4* ↓

beste Teiler: 105.5 (14.), 114.5 (13.), 121.2 (11.)
 Trefferlage: 1.25 mm links, 1.20 mm tief
 Streuwert: 2.50, horizontal: 1.94, vertikal: 2.96

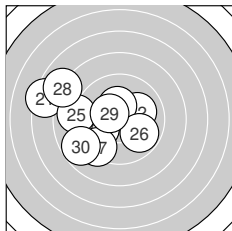

Serie 3: 92.7 (87)

7.3 ↖	10.1 →	10.3* ↑	9.9 ↖	8.9 ↖
9.8 ↘	9.3 ↗	7.9 ↖	10.4* ↖	8.8 ↗

beste Teiler: 135.3 (29.), 158.1 (23.), 222.8 (22.)
 Trefferlage: 2.68 mm links, 0.07 mm hoch
 Streuwert: 3.02, horizontal: 3.60, vertikal: 2.30

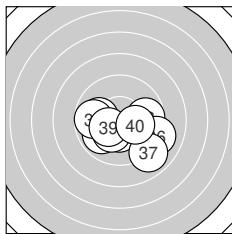

Serie 4: 98.5 (94)

10.0 ↖	10.4* ↓	9.7 →	9.9 ↖	9.7 ↖
9.1 ↘	8.9 ↘	10.3* ↗	10.3* ↖	10.2* →

beste Teiler: 148.0 (32.), 153.1 (39.), 173.4 (38.)
 Trefferlage: 0.27 mm rechts, 1.07 mm tief
 Streuwert: 2.07, horizontal: 2.65, vertikal: 1.26

